

# Televés

SMATV

Repartidores EMC  
Repartidores EMC  
Répartiteurs EMC  
Splitters EMC  
Partitori EMC

Ref. 5454

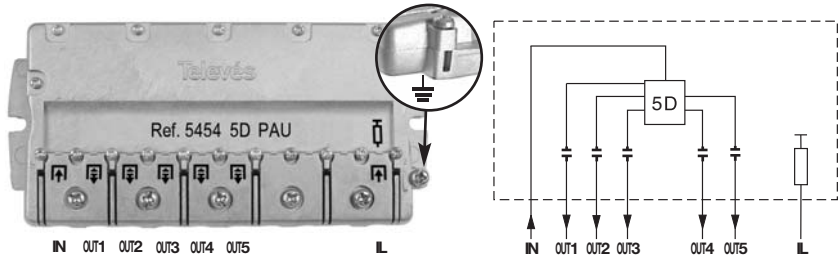

Ref. 5430

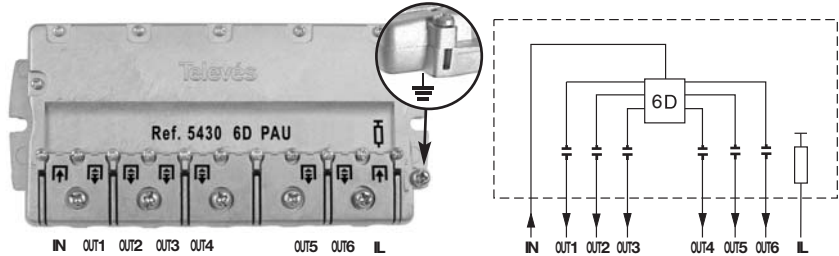

Ref. 5433

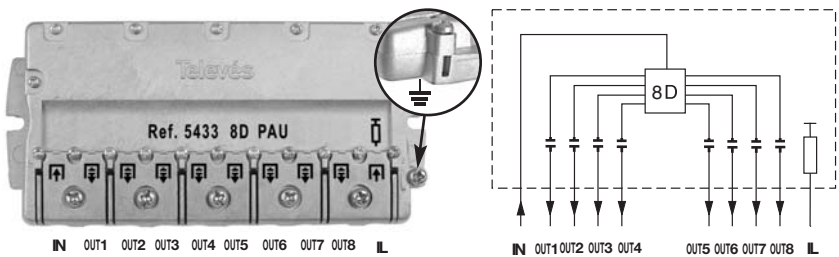

# Televes

SMATV

Repartidores EMC  
Repartidores EMC  
Répartiteurs EMC  
Splitters EMC  
Partitori EMC

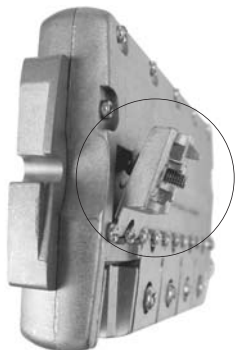

Anclaje de brida para facilitar el conexionado.

*Encaixe da braçadeira para facilitar a ligação.*

Fixation de la bride pour simplifier la connexion.

*Cable clamp joint for easy connection.*

Esempio di preparazione di spelatura del cavo per un semplice collegamento.

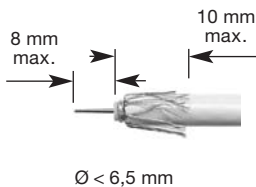
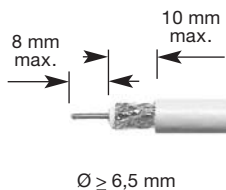

Mismo pelado para cables de una misma brida.  
*Mesmo descarnado para cabos da mesma braçadeira*  
Même découpe du câble par bride  
*Same stripping for cables with the same clamp.*  
Stessa spelatura per cavi di collegamenti uguali.

Características técnicas		Características técnicas		Spécifications techniques		Technical specifications		Caratteristiche tecniche	
Referencia	Referencia	Referencia	Referencia	Referencia	Referencia			5454	5430
Margen frec.	Margem freq.	Marge freq.	Freq. range	Gamma di frequenza	(MHz)				
Atenuación	Atenuação	Atténuation	Attenuation	Attenuazione	Attenuazione	IN => OUT 1,2 (dB)	5 - 47 MHz	<15	<14
							47 - 862 MHz	13± 1	14± 1
							950 - 2400 MHz	13± 2	14± 2
Atenuación	Atenuação	Atténuation	Attenuation	Attenuazione	Attenuazione	IN => OUT 3,4 (dB)	5 - 47 MHz	<15	<17
							47 - 862 MHz	11± 1	12± 1
							950 - 2400 MHz	11± 2	12± 1
Atenuación	Atenuação	Atténuation	Attenuation	Attenuazione	Attenuazione	IN => OUT 5,6 (dB)	5 - 47 MHz	<15	<16
							47 - 862 MHz	11± 1	13± 2
							950 - 2400 MHz	11± 2	11± 1
Atenuación	Atenuação	Atténuation	Attenuation	Attenuazione	Attenuazione	IN => OUT 7,8 (dB)	5 - 47 MHz	---	---
							47 - 862 MHz	---	<20
							950 - 2400 MHz	---	15± 2
Rechazo entre salidas	Rejeição entre saídas	Réject entre sorties	Rejection between outputs	Separazione tra uscite	Separazione tra uscite	(dB)	5 - 47 MHz	>30	>30
							47 - 862 MHz	>28	>28
							950 - 2400 MHz	>28	>28

Aplicación

Aplicação

Application

Application

Aplicazione

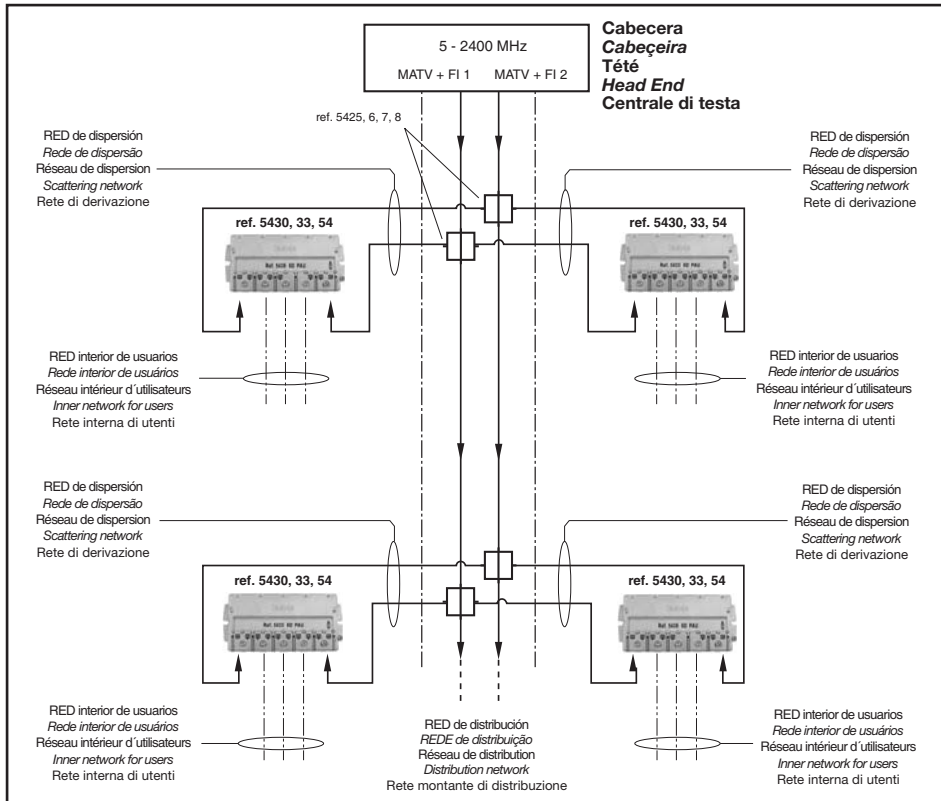

**Televes S.A.** declara bajo su exclusiva responsabilidad la conformidad de éste producto con las Directivas 89/336/CEE y 73/23/CEE. Puede obtener la Declaración de Conformidad e información complementaria en la página Web:

**Televes S.A.** hereby states, under its own responsibility, that this product is in compliance with the orders of the Directives 89/336/EEC and 73/23/EEC. You can obtain the Declaration of Conformity and complementary information in the Web page:

<http://www.televes.com>



01030152-000