

Antena de recepción satélite plana con LNB individual integrado SlimSat SA61
Antena de recepción satélite plana con LNB doble integrado SlimSat SA62
Antena de recepción satélite plana con LNB quad integrado SlimSat SA64



Picture similar

Manual del usuario



TABLA DE CONTENIDOS

1.0 QUE ES SLIMSAT?	2
2.0 INSTRUCCIONES DE SEGURIDAD	2
3.0 CÓMO INSTALAR LA ANTENA	3
3.1 Paso 1: Donde instalar	3
3.2 Paso 2: Instalación	4
3.3 Paso 3: Conexión de la antena al receptor	6
3.4 Paso 4: Ajuste y Fijación final	6
4.0 LOCALIZACIÓN DE LOS DEFECTOS	7
5.0 PÉRDIDA DE SEÑAL	8
6.0 INSTALACIONES QUE USAN UN CABLE LARGO	8
7.0 CARACTERÍSTICAS TECNICAS	8
A.1 CONTENIDO DE LA CAJA	9
A.2 APPENDIX	

1.0 QUE ES SLIMSAT?

SLIMSAT es una Antena Satélite de tipo Cornete para Doble Polarización Lineal que puede recibir señales de los principales satélites y reemplazar una antena parabólica antigua.

Pequeña, discreta y fácil de usar, se puede instalar en pocos minutos y usar como antena móvil.

SLIMSAT puede usarse para los canales de recepción gratuitos y codificados, así como para recibir todos los canales HD con alta definición de imagen.

Para poder usarla e instalarla, le rogamos siga las instrucciones y materiales de instalación siguientes con mucho cuidado.

SlimSat SA61 con LNB individual para conectar un receptor de satélite

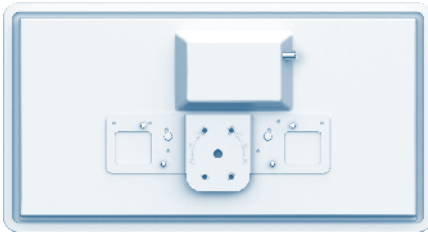

SlimSat SA62 con LNB doble integrado para conectar dos receptores de satélite

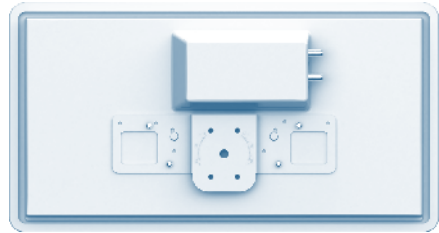

SlimSat SA64 con LNB Quad integrado para conectar hasta cuatro receptores de satélite

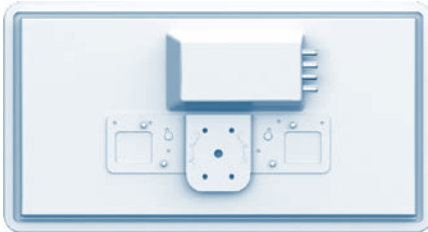

2.0 INSTRUCCIONES DE SEGURIDAD

- Antes de usar este producto, rogamos lea atentamente este manual y siga exactamente todas las instrucciones de instalación, de montaje y de orientación.
- Tiene que respetar todas las instrucciones para evitar cualquier problema de funcionamiento o técnico.
- Cualquier campo eléctrico o magnético que se encuentre cerca de SLIMSAT puede causar una recepción insuficiente de las señales, hasta cortar por completo la recepción de las mismas.
- No se debe perforar la tapa de plástico de la antena, que permite una impermeabilización absoluta en caso de lluvia y de mal tiempo; en caso contrario, su producto podría no funcionar correctamente.
- Cualquier caída o choque brusco puede dañar la antena o el funcionamiento de la misma.
- No abrir la tapa frontal o posterior; cualquier intento de reparación por una persona no cualificada puede ser peligroso.

- Cualquier obstáculo (edificio, árboles, etc.) puede bloquear la recepción de la señal del Satélite.
- No pintar ni añadir ninguna sustancia a la tapa de la antena, lo que bloquearía la recepción de la señal del Satélite.
- La antena no deber estar demasiado alejada de su receptor de Satélite; un cable largo (> 30 m) disminuye la calidad de la señal.
- El uso de un cable largo o conexiones no aisladas puede conllevar la pérdida del nivel de la señal.
- Para optimizar la recepción de la señal, rogamos utilice la pantalla de ajuste de su receptor para las primeras instalaciones.
- No olvide regular la antena y la abrazadera a la polaridad y el ángulo de inclinación.
- Apretar todos los tornillos de la antena después de acabar los ajustes para evitar un cambio de orientación debido al viento o al mal tiempo.
- Este producto contiene el LNB, y está totalmente prohibido añadir, cambiar o modificar el LNB original.
- Para más detalles específicos sobre los puntos anteriores o para cualquier información, le rogamos contacte directamente con el servicio cliente de su tienda.



¡¡¡AVISO!!!

Las antenas que no estén instaladas adecuadamente o cuya estructura no es la adecuada, pueden dañarse. Este daño puede ser muy grave e incluso constituir un peligro. El propietario o instalador asume la plena responsabilidad de la seguridad de la instalación desde el punto de vista de la estructura, que soporta todas las cargas (peso, viento y hielo) y que está adecuadamente impermeabilizada contra las fugas. El fabricante no aceptará responsabilidad alguna por daño causado por un sistema Satélite debido a las múltiples aplicaciones variables y desconocidas.

3.0 CÓMO INSTALAR LA ANTENA

Siguiendo las instrucciones paso a paso, puede instalar fácilmente SLIMSAT Usted mismo o con la ayuda de un instalador profesional de antenas.

Ante de instalar su antena compruebe que la caja SLIMSAT contiene todos los artículos indicados en el contenido de la misma; en caso de que falte algún accesorio, rogamos contacte con su distribuidor.

3.1 Paso 1: Donde instalar

Para poder recibir la señal de los satélites, conviene instalar el SLIMSAT en un espacio abierto (en el exterior de la casa o piso) orientado hacia el ecuador (Sur). Por ello, necesitará la ayuda de una brújula para orientar exactamente la antena SLIMSAT en dirección del Satélite. (Nota; refiérase a la tabla de los ángulos de azimut especificados en las últimas páginas de este manual)



Nota

para asegurarse de una lectura correcta de la brújula, manténgase alejado de objetos metálicos grandes, en particular los cables de alta tensión, y realice varias lecturas.



Compruebe que no hay obstáculos frente al SLIMSAT, que puedan disminuir la calidad de recepción de la señal tales como: edificios, árboles (hay que tomar en cuenta el hecho de que los árboles crecerán en altura y en anchura y que pueden boquear la señal).

Para poder fijar e instalar fácilmente su antena, deberá elegir un lugar de fácil acceso que no presente ningún peligro para la instalación.

Encuentre una forma discreta de pasar su cable del SLIMSAT hacia su aparato integrado convertidor-decodificador. La antena no debe estar demasiado alejada de su receptor de Satélite; un cable de más de 30 metros disminuye la calidad de la señal.

Señal de recepción de mala calidad

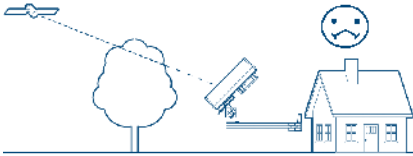

Señal de recepción de buena calidad

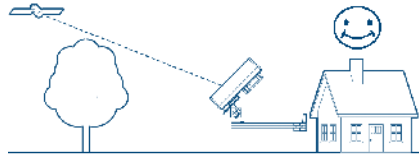

3.2 Paso 2: Instalación

Antes de instalar la antena es necesario encontrar la elevación, el azimuth y el skew en relación a su posición geográfica. Estos parametros se encuentran en la tabla al final de este manual.

Por ejemplo si deseamos recibir el satellite Hispast 1C, 1D 30W en la región de Albacete los parametros son

Azimet:	220,4°
Elevación:	36,3°
Skew:	30,3°

Montaje

1. Ajustar el Skew (Fijar el cuerpo de la antena A1 al soporte B1)

Juntar el soporte B1 al cuerpo de la antena y ajustar el Skew a 30,3

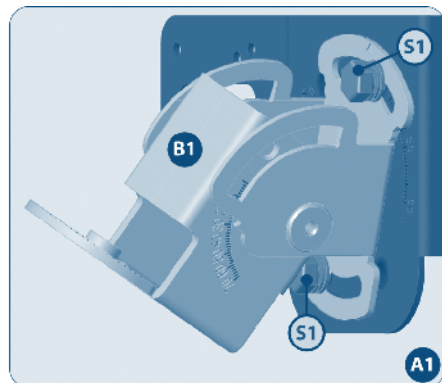
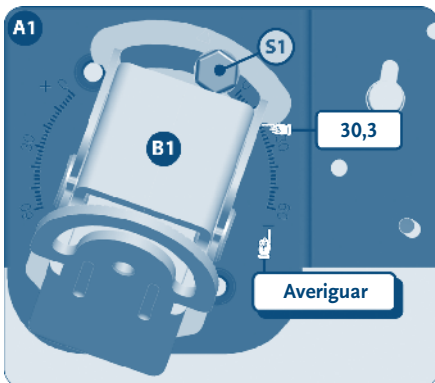

2. Ajuste de la Elevación y Azimut (Fijar el cuerpo antena A1 + soporte B1 al soporte principal B2)

Para el ajuste final de la elevación y del azimuth no aprete demasiado los tornillos N1, S1 y S3.

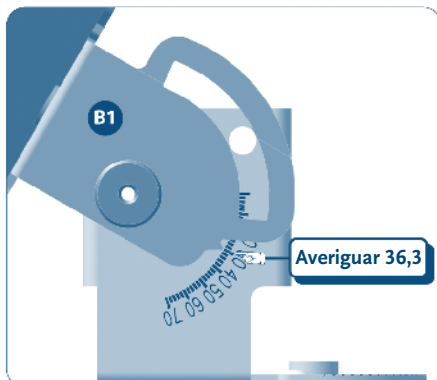
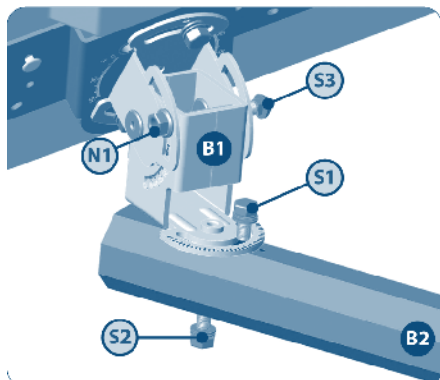

3. Instalación de la abrazadera B3

Antes de instalar la abrazadera B3, tome en consideración donde se va a instalar (mástil o pared).

Averigue que la abrazadera esté orientada hacia el satélite. Para soportar el peso de la antena apretar lo mas fuerte posible el tornillo N1.

Para la fijación a la pared utilice los tornillos mas adecuados al material (no incluidos).

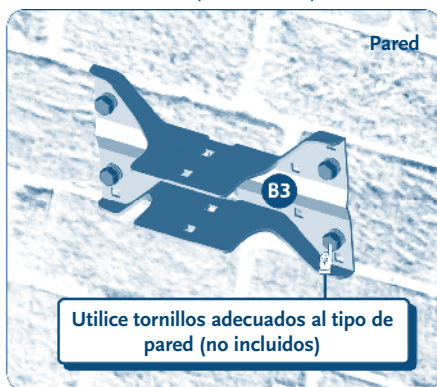
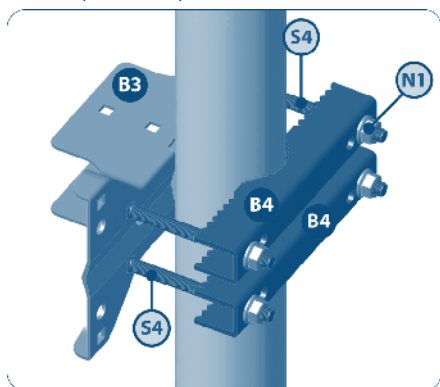

4. Montaje del cuerpo de la antena A1 + soporte B1 + soporte principal B2 a la abrazadera B3.

Para soportar el peso de la antena el apretar lo mas fuerte posible el tornillo N1

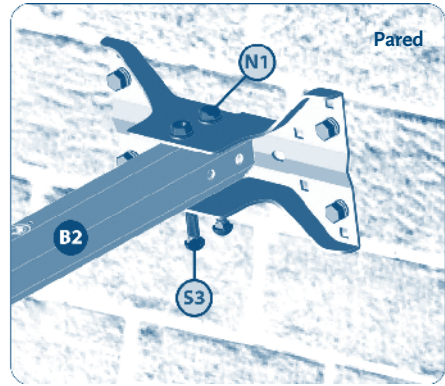
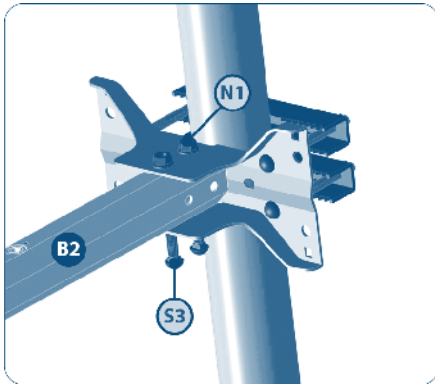

3.3 Paso 3: Conexión de la antena al receptor

Cuando haya terminado la instalación la antena puede conectarla al receptor.

El cable entre la antena y su receptor de Satélite no debe superar los 30 metros porque eso disminuiría la calidad de la señal.

El uso de un cable largo o de mala calidad y de conectores no aislados puede provocar una pérdida de nivel de señal, por lo que es preferible usar un cable coaxial RG6 Coaxial, para evitar una pérdida de señal.

Como poner el conector al cable

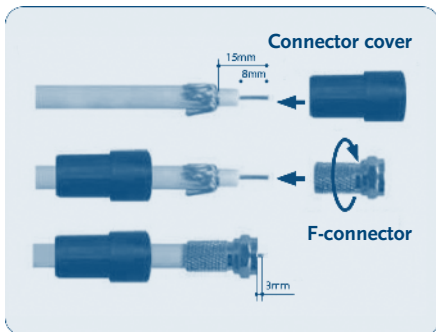

B- Cómo conectar el cable al receptor



Es importante que el cable coaxial no se haya dañado o doblado durante la instalación

3.4 Paso 4: Ajuste y Fijación final

Encienda la televisión y el receptor, entre en el Menu Instalación y seleccione el menu de ajuste de la antena (vea el manual del receptor) y controle el nivel de la señal en la pantalla. No se olvide de seleccionar "LNB: ON".

El nivel de la señal variaran durante el ajuste. Una vez obtenido el maximo nivel y la maxima calidad aprete con fuerza todos los tornillos.

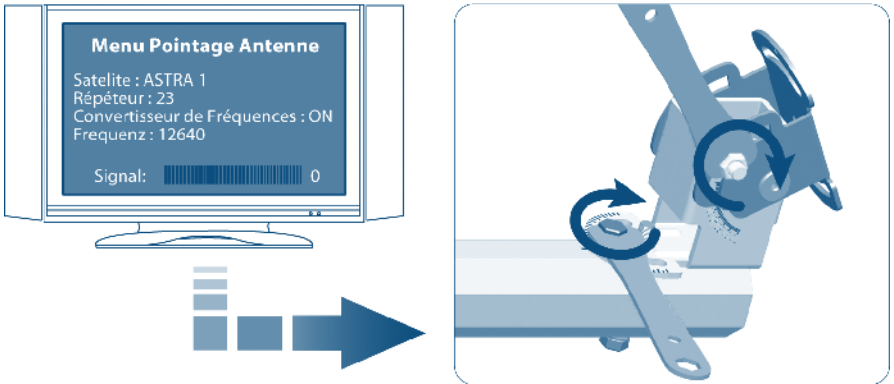

4.0 LOCALIZACIÓN DE LOS DEFECTOS

Si la señal no se encuentra, asegúrese de que el manual de utilización del receptor y el manual de utilización de la antena han sido seguidos adecuadamente, compruebe lo siguiente:

- Asegúrese que todas las conexiones del cable están correctas y que cada una está sellada y ajustada correctamente.
- Inspeccione el interior de cada conector del cable para detectar posibles suciedades o posible conexión con la caja, escudo o corto.
- Asegúrese que los apuntadores de elevación e inclinación estén alineados correctamente a las escalas. No use la arandela o tuerca como referencia.
- Asegúrese de que el ajuste de inclinación no ha cambiado respecto al ajuste recomendado para la ubicación de la antena.
- Retire los componentes específicos de la TV, tales como divisores, etc. que reduzcan la instalación a las conexiones básicas explicadas en este manual. Tales componentes pueden no funcionar con la señal del satélite y pueden estar en la pared en un lugar donde no se puedan ver. En caso de duda, conecte el cable RG6 directamente a su receptor.
- Asegúrese que no hay obstrucciones (árboles, edificios, ventanas, esquinas o salientes de su techo, su cuerpo o sus manos) la señal no atraviesa hojas, ramas, cristales, etc.
- El cable RG6 con centro de cobre sólido está muy recomendado porque tiene menor carga de voltaje DC comparado con el cable RG6 con malla de cobre y centro de acero.
- El cable Standard RG59 causa mucha caída de voltaje y caída de señal y no debe ser utilizado para señales de satélite. Solo se debe usar el cable RG6.
- Algunos componentes adicionales comprados en la misma tienda pueden no resultar como se pretendía. Pueden no funcionar o causar caídas adicionales de voltaje y disminución de la amplitud de la señal. Retire dichos componentes y vuelva a las conexiones básicas citadas en este manual, y compruebe todo de nuevo.
- Asegúrese de que el cable está conectado al enchufe "SAT IN" y no a la "ANTENA IN". El enchufe "ANTENA IN" de la parte trasera del receptor sirve para la entrada de la antena aérea o para la entrada de la TV por cable.

- Si todo está hecho correctamente pero la señal aún no aparece, modifique suavemente la elevación de la antena (+/- 2°, luego +/- 4° de la instalación) y repita el procedimiento.
- Asegúrese de que la tarjeta de acceso de su receptor está insertada correctamente en la ranura Tarjeta de Acceso y orientada correctamente.

5.0 PÉRDIDA DE SEÑAL

- La señal del satélite puede perderse temporalmente debido a una lluvia más fuerte de lo habitual. Una antena óptimamente alineada así como un cableado mas corto posible minimizan las posibilidades de un fundido causado por lluvia.
- Asegúrese que la antena está fijada fuertemente para prevenir que un fuerte viento la mueva de su alineación.
- La acumulación de mucha nieve sobre la antena puede reducir la fuerza de la señal satelital, la nieve debe ser retirada cuanto antes.
- El follaje acumulado sobre la antena puede tener como consecuencia una pérdida gradual de la imagen.

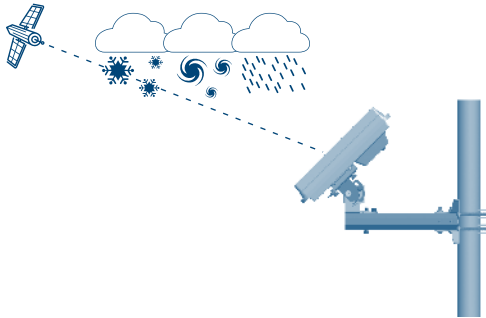

6.0 INSTALACIONES QUE USAN UN CABLE LARGO

Para instalaciones en las que el cable RG6 que va desde el (los) receptor(es) al LNB supera los 30m como puede suceder en edificios comerciales o viviendas múltiples, tendrá que utilizar un amplificador de señal RF para compensar la pérdida de la señal. En caso contrario, su antena y receptor pueden no funcionar correctamente y estar sometidos a frecuentes cortes en caso de mal tiempo. Contacte con un profesional para gestionar tales instalaciones.

7.0 CARACTERÍSTICAS TÉCNICAS

Frecuencia Satélite de entrada:	10.7 – 12.75 GHz
Polarización:	Doble Lineal (Horizontal y Vertical)
Ganancia de la Antena:	33.7 dBi at 12.7 GHz
Dimensiones (W x H x P):	51.7 x 27.7 x 8.2 cm
LNB:	Modelo SA61: LNB individual integrado Modelo SA62: LNB doble integrado Modelo SA64: LNB Quad integrado
Frecuencia de salida del LNB:	950 – 1,950 / 1,100 – 2,150 MHz

Voltage LNB: Vertical 9 ~ 14.5 V (tip. 13 V)
 Horizontal 15.5 ~ 24 V (tip. 18 V)





Temperatura de funcionamiento: -30 ~ +60 °C



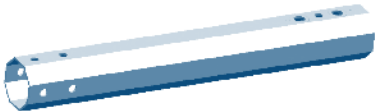
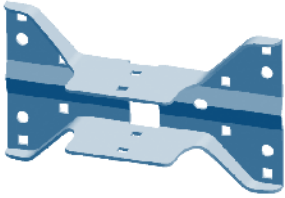

Peso lordo: 4.5 kg

Peso neto: 2.7 kg

Como consecuencia de una búsqueda y desarrollos tecnológicos las características técnicas y el aspecto físico de los productos pueden cambiar.
 ASTRA es una marca registrada de SES ASTRA. Eutelsat y HOT BIRD are son marcas registradas de Eutelsat Communications. Todas las demas marcas son marcas o marcas registradas de los respectivos propietarios.
 © STRONG 2010. Todos los derechos reservados. 06/2010

A.1 CONTENIDO DE LA CAJA

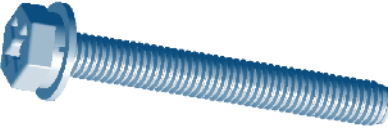
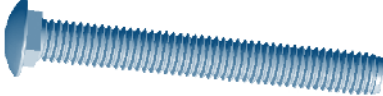
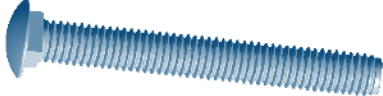
No	Símbolo	Nombre de la pieza	Imagen	Cantidad
1	A1	Cuerpo de la antena		1
2	B1	Abrazadera de ángulo		1
3	B2	Soporte principal		1
4	B3	Abrazadera de fijación A		1
5	B4	Abrazadera de fijación B		2

No	Símbolo	Nombre de la pieza	Imagen	Cantidad
6	B5	Llave de tornillo		1
7	C1	Brújula		1
8	S1	Tornillo M6x18 SEMS2		3
9	S2	Tornillo M6x50 SEMS2		1
10	S3	Tornillo de cabeza redondeada con cuello cuadrado M6x50		3
11	S4	Tornillo de cabeza redondeada con cuello cuadrado M6x75		4
12	N1	Tuerca con resalto M6		7

A.2 APPENDIX

Great Britain

eL=East Longitude wL=West Longitude B=Latitude Az=Azimuth El=Elevation Sk = Skew

		Turk sat	Astra 2A/2B/2D	Astra 1E-1H /1KR/2C	Hot bird 2/B/7A /B	Atlant lbrld	Hispa sat		Turk sat	Astra 2A/2B/2D	Astra 1E-1H /1KR/2C	Hot bird 2/B/7A /B	Atlant lbrld	Hispa sat	
		IC,2A	Euro bird 1		3	3	IC,1D		IC,2A	Euro bird 1		3	3	IC,1D	
		42.0 E	28.2 E	19.2 E	13.0 E	5.0 W	30.0 W		42.0 E	28.2 E	19.2 E	13.0 E	5.0 W	30.0 W	
Aberdeen wL 2.1 B+57.1	Az	130.9	145.2	155.1	162.2	183.5	212.2	Iverness wL 4.2 B+57.5	Az	129.0	143.0	152.8	159.8	180.9	209.8
	El	14.6	19.8	22.4	23.7	25.0	20.6		El	13.4	18.8	21.5	22.9	24.6	20.8
	Sk	-24.2	-18.1	-13.2	-9.6	1.9	16.8		Sk	-24.7	-18.9	-14.2	-10.7	0.5	15.5
Delfist wL 5.9 B+54.6	Az	126.3	140.2	150.1	157.2	178.9	208.7	Kingston upon hull wL 0.33 B+53.75	Az	131.5	146.0	156.3	163.6	185.8	215.2
	El	14.4	20.5	23.7	25.4	27.7	24.0		El	17.6	23.4	26.1	27.4	28.5	22.9
	Sk	-27.8	-21.7	-16.8	-13.0	-0.6	16.2		Sk	-26.3	-19.3	-13.8	-9.5	3.4	20.0
Birmingham wL 1.8 B+52.5	Az	129.6	143.9	154.1	161.5	184.0	214.0	Leeds wL 1.6 B+53.8	Az	130.3	144.7	154.8	162.1	184.2	213.8
	El	17.8	23.9	26.9	28.4	29.9	24.8		El	17.0	22.8	25.7	27.1	28.5	23.3
	Sk	-28.0	-21.0	-15.4	-11.1	2.5	19.9		Sk	-26.8	-20.0	-14.6	-10.5	2.5	19.2
Bradford wL 1.9 B+53.8	Az	130.1	144.5	154.6	161.9	184.0	213.7	Liverpool wL 2.9 B+53.4	Az	128.8	143.1	153.2	160.4	182.6	212.5
	El	16.9	22.8	25.7	27.1	28.5	23.4		El	16.6	22.7	25.7	27.3	29.0	24.1
	Sk	-26.9	-20.1	-14.7	-10.6	2.3	19.1		Sk	-27.7	-21.0	-15.6	-11.5	1.6	18.7
Bristol wL 2.6 B+51.5	Az	128.4	142.7	152.9	160.4	183.1	213.6	Leicester wL 1.08 B+52.63	Az	130.4	144.8	155.1	162.5	184.9	214.8
	El	18.1	24.5	27.7	29.3	31.1	25.8		El	18.1	24.1	27.0	28.4	29.7	24.2
	Sk	-29.2	-22.2	-16.5	-12.1	1.9	20.1		Sk	-27.6	-20.5	-14.8	-10.5	3.0	20.3
Cardiff wL 3.16 B+51.48	Az	127.9	142.1	152.3	159.7	182.4	212.9	London wL 0.2 B+51.5	Az	130.6	145.4	155.8	163.4	186.2	216.2
	El	17.8	24.3	27.5	29.2	31.1	25.9		El	19.3	25.4	28.3	29.8	30.9	24.8
	Sk	-29.4	-22.5	-16.9	-12.5	1.5	19.8		Sk	-28.1	-20.7	-14.8	-10.3	3.9	21.6
Chichester wL0.778 B+53.7	Az	130.0	144.5	154.9	162.4	185.4	213.8	Manchester wL 2.3 B+53.8	Az	129.5	143.8	154.0	161.3	183.4	213.2
	El	19.4	25.8	28.9	30.4	31.5	25.6		El	16.9	22.9	25.8	27.3	28.9	23.8
	Sk	-29.0	-21.5	-15.6	-11.0	3.4	21.7		Sk	-27.3	-20.6	-15.2	-11.1	2.0	19.0
Covey wL1.5 B+52.42	Az	129.9	144.3	154.5	161.9	184.4	214.4	Newcastle upon Tyne wL 1.6 B+55.0	Az	130.7	145.0	155.1	162.4	184.1	213.4
	El	18.0	21.1	27.0	28.6	30.0	24.5		El	16.2	21.8	24.5	25.9	27.2	22.3
	Sk	-27.9	-20.9	-15.2	-10.9	2.7	20.2		Sk	-25.8	-19.2	-14.0	-10.0	2.4	18.4
Dover eL 1.3 B+51.1	Az	132.1	146.9	157.5	165.1	188.1	218.0	Norwich eL 1.3 B+52.6	Az	132.7	147.4	157.9	165.4	187.9	217.4
	El	20.3	26.3	29.1	30.5	31.2	24.6		El	19.2	24.9	27.6	28.9	29.6	23.3
	Sk	-27.8	-20.1	-13.9	-9.3	5.1	22.7		Sk	-26.5	-19.1	-13.2	-8.8	4.8	21.7
Edinburgh wL 3.2 B+56.0	Az	129.4	143.6	153.6	160.7	182.2	211.4	Nottingham wL 1.3 B+52.9	Az	130.2	144.6	154.9	162.3	184.6	214.5
	El	14.8	20.4	23.2	24.6	26.2	21.9		El	17.8	23.7	26.6	28.1	29.5	24.0
	Sk	-25.6	-19.4	-14.4	-10.7	1.2	16.9		Sk	-27.4	-20.4	-14.8	-10.6	2.9	20.0
Glasgow wL 4.2 B+55.9	Az	128.4	142.5	152.4	159.5	180.9	210.2	Plymouth wL 4.2; B+50.4	Az	126.5	140.5	150.7	158.1	181.0	212.1
	El	14.4	20.1	23.0	24.5	26.4	22.3		El	17.9	24.7	28.2	30.0	32.3	27.8
	Sk	-26.0	-19.9	-15.1	-11.3	0.5	16.4		Sk	-30.8	-23.9	-18.2	-13.8	0.7	19.8
Greenwich eL0 B+51.48	Az	131.0	145.8	153.0	158.0	186.4	216.4	Portsmouth wL 1.1 B+50.8	Az	129.6	144.1	154.5	162.0	185.0	215.5
	El	19.4	25.5	28.4	28.4	30.9	24.7		El	19.3	25.6	28.7	30.3	31.7	25.8
	Sk	-28.0	-20.6	-14.7	-14.7	4.0	21.7		Sk	-29.1	-21.8	-15.8	-11.2	3.2	21.5
Swansea wL 4.0 B+51.6	Az	127.1	141.2	151.3	158.7	181.3	211.9	Stafford wL 1.5 B+53.4	Az	130.2	144.8	154.8	162.1	184.4	214.1
	El	17.3	23.8	27.1	28.8	31.0	26.1		El	17.3	23.2	26.1	27.6	28.9	23.7
	Sk	-29.7	-22.9	-17.3	-13.1	0.8	19.2		Sk	-27.1	-20.2	-14.7	-10.5	2.6	19.5
Wolverhampton wL 2.2 B+52.6	Az	129.2	143.6	153.7	161.1	183.5	213.6	Southampton wL1.38 B+50.9	Az	129.4	143.8	154.2	161.7	184.7	215.1
	El	17.5	23.6	26.7	28.2	29.8	24.6		El	19.1	25.5	28.6	30.1	31.6	25.8
	Sk	-28.1	-21.2	-15.6	-11.3	2.1	19.6		Sk	-28.2	-21.9	-15.9	-11.4	2.9	21.3
York wL1.08 B+53.95	Az	130.9	145.3	155.4	162.6	184.8	214.4								
	El	17.2	22.9	25.7	27.1	28.3	23.0								
	Sk	-26.4	-19.6	-14.2	-10.0	2.9	19.4								

*Note: If you are missing the city you are living in, please visit <http://www.lyngsat.com/>

Germany

eL=East Longitude wL=West Longitude B=Latitude Az=Azimuth EI=Elevation Sk : Skew

	Turk sat	Astra 2A/2B /2D		Astra 1E-1H /1KR/ 2C	Hot bird 2/6/7A /8	Alliant lbird	Hispa sat		Turk sat	Astra 2A/2B /2D		Astra 1E-1H /1KR/ 2C	Hot bird 2/6/7A /8	Alliant lbird	Hispa sat
		IC,2A	Euro bird 1	19.2	13.0	6.0	3.0			IC,2A	Euro bird 1	19.2	13.0	6.0	3.0
		42.0	28.2	19.2	13.0	6.0	3.0			42.0	28.2	19.2	13.0	6.0	3.0
		E	E	E	E	W	W			E	E	E	E	W	W
Aachen eL 6.1 B + 50.8	Az	136.9	152.3	163.3	171.1	194.2	223.2	Frankfurt am Main eL 8.7 B + 50.1	Az	136.4	155.2	166.4	174.4	197.6	228.2
	Sk	-25.6	-17.1	-10.5	-5.6	8.9	25.7		Az	24.5	29.6	31.7	32.4	31.1	22.0
Aalen eL 10.1 B + 48.8	Az	140.4	156.5	168.0	176.2	199.7	226.2	Freising eL 11.8 B + 48.4	Az	142.1	158.5	170.1	178.3	201.9	230.0
	Sk	-24.8	-15.2	-7.9	-2.5	12.9	29.4		EI	27.3	32.2	34.0	34.4	32.1	21.6
Aschaffenburg eL 9.2 B + 50.0	Az	139.9	155.7	167.0	175.0	198.2	226.8	Göttingen eL 9.9 B + 51.5	Az	141.3	157.1	168.2	176.1	198.8	226.9
	FI	24.8	29.9	31.9	32.6	31.2	21.9		FI	23.9	28.6	30.4	31.0	29.4	20.4
Augsburg eL 10.9 B + 48.4	Sk	-24.4	-15.3	-8.9	-3.2	11.7	27.9	Hannburg eL 10.0 B + 53.6	Sk	-22.9	-14.0	-7.3	-2.5	11.6	27.0
	Az	141.1	157.4	169.0	177.2	200.9	229.2		Az	142.2	157.8	168.7	178.3	198.5	226.2
Bad Herfeld eL 9.7 B + 50.9	EI	26.9	32.0	33.9	34.4	32.4	22.1	Heide eL 9.1 B + 54.2	EI	22.2	26.6	28.3	28.8	27.3	18.8
	Sk	-24.6	-14.8	-7.3	-1.9	13.7	30.2		Sk	-21.3	-13.0	-6.7	-2.2	10.8	25.4
Bad Horb eL 8.6 B + 50.2	Az	140.8	156.7	167.8	175.8	198.7	227.0	Heidelberg eL 8.7 B + 49.4	Az	141.4	156.9	167.3	175.2	197.2	225.1
	EI	24.3	29.2	31.1	31.7	30.1	20.9		EI	21.3	25.7	27.5	28.0	26.8	18.8
Bad Neuenahr eL 7.1 B + 50.6	Sk	-23.5	-14.5	-7.6	-2.7	11.7	27.4	Ho eL 11.9 B + 50.3	Sk	-21.4	-13.3	-7.2	-2.8	10.0	24.5
	Az	139.4	155.2	166.3	174.3	197.5	226.1		Az	139.1	155.0	166.3	174.3	197.8	226.5
Baden- Baden eL 8.2 B + 48.8	EI	24.4	29.5	31.6	32.3	31.0	21.9	Köln eL 7.0 B + 51.0	EI	25.1	30.3	32.5	33.2	31.9	22.5
	Sk	-24.6	-15.6	-8.7	-3.7	11.1	27.5		Sk	-25.2	-16.0	-8.9	-3.7	11.5	28.2
Bamberg eL 10.9 B + 49.9	Az	137.9	153.5	164.5	172.4	195.5	224.4	Liljebäck eL 10.7 B + 53.9	Az	143.0	159.2	170.5	178.6	201.6	229.4
	EI	23.5	28.8	31.0	31.8	31.0	22.4		EI	25.7	30.3	31.9	32.3	30.2	20.2
Berg eL 13.4 B + 54.4	Sk	-25.2	-16.5	-9.8	-4.8	9.8	26.4	München eL 11.6 B + 48.1	Sk	-22.6	-13.1	-6.0	-0.9	13.8	29.0
	Az	138.4	154.2	165.6	173.7	197.4	226.3		Az	137.9	153.4	164.4	172.2	195.2	224.1
Berlin eL 13.4 B + 52.5	EI	25.4	30.8	33.1	33.9	32.6	23.2	Münster eL 8.9 B + 49.9	EI	23.1	28.3	30.5	31.4	30.6	22.2
	Sk	-26.0	-16.7	-9.5	-4.2	11.3	28.4		Sk	-24.9	-16.3	-9.7	-1.8	9.6	26.6
Bingen eL 9.3 B + 48.1	Az	141.7	157.8	169.2	177.2	200.4	228.5	Nienburg eL 11.8 B + 51.8	Az	143.0	158.7	169.5	177.1	199.2	228.0
	EI	25.6	30.5	32.3	32.8	30.8	21.0		EI	22.2	26.4	28.0	28.5	26.8	18.3
Bonn eL 7.1 B + 50.7	Sk	-23.5	-14.1	-6.9	-1.8	13.0	29.9	Offenburg eL 8.0 B + 48.5	Sk	-20.8	-12.4	-6.2	-1.7	11.2	25.4
	Az	146.2	162.0	172.9	180.5	202.3	229.3		Az	141.7	158.1	169.8	178.1	201.8	230.0
Bremen eL 8.6 B + 53.1	EI	22.7	26.5	27.7	27.9	25.7	16.7	Passau eL 13.5 B + 48.6	EI	27.4	32.4	34.2	34.7	32.4	21.9
	Sk	-18.9	-10.4	-4.1	0.3	12.7	26.2		Sk	-24.4	-14.4	-6.8	-1.3	14.4	30.8
Chemnitz eL 12.9 B + 50.8	Az	145.5	161.6	172.7	180.5	202.8	230.0	Pöchlarn eL 12.1 B + 54.1	Az	139.5	155.4	166.6	174.6	197.9	226.5
	EI	24.4	28.4	29.7	30.0	27.6	18.0		EI	24.7	29.9	31.9	32.6	31.3	22.0
Deggendorf eL 13.0 B + 48.8	Sk	-20.2	-11.1	-4.4	0.3	13.6	27.8	Regensburg eL 8.0 B + 48.5	Sk	-24.7	-15.6	-6.6	-3.5	11.4	27.9
	Az	139.2	155.3	166.8	175.0	198.9	227.7		Az	143.5	159.4	170.6	178.4	201.0	228.6
Dortmund eL 7.5 B + 51.5	EI	26.4	31.8	33.9	34.6	33.0	23.1	Traunstein eL 12.7 B + 47.9	EI	24.4	28.7	30.3	30.7	28.7	19.2
	Sk	-25.9	-16.2	-8.8	-3.3	12.5	29.6		Sk	-21.6	-12.5	-5.8	-0.9	12.8	27.7
Düsseldorf eL 6.8 B + 51.2	Az	138.0	153.5	164.5	172.4	195.5	224.3	Ulm eL 10.0 B + 48.4	Az	137.9	153.8	165.1	173.3	197.1	226.2
	EI	23.3	28.6	30.8	31.6	30.8	22.3		EI	25.5	31.0	33.3	34.2	33.0	23.6
Erfurt eL 10.9 B + 49.9	Sk	-25.1	-16.4	-9.7	-4.8	9.7	26.3	Weilheim eL 8.0 B + 48.5	Sk	-28.3	-17.0	-9.8	-4.4	11.3	28.6
	Az	140.7	156.2	167.1	174.8	197.1	225.2		Az	144.1	160.7	172.4	180.6	204.0	231.7
Frankfurt am Main eL 8.7 B + 50.1	EI	22.1	26.8	28.6	29.2	26.0	19.7	Wiesbaden eL 8.0 B + 48.5	EI	27.9	32.5	34.0	34.3	31.5	20.6
	Sk	-22.4	-14.0	-7.7	-3.2	10.2	25.2		Sk	-22.8	-12.6	-5.0	0.4	15.6	31.3
Gießen eL 9.9 B + 51.5	Az	144.3	160.6	171.9	179.9	202.6	230.2	Witten eL 8.0 B + 48.5	Az	144.7	160.4	171.3	178.9	200.8	228.2
	EI	25.7	30.0	31.5	31.8	29.4	19.4		EI	22.6	26.5	27.9	28.3	26.3	17.5
Hannover eL 9.1 B + 52.2	Sk	-21.6	-12.2	-5.1	-0.1	14.1	29.0	Worms eL 8.0 B + 48.5	Sk	-19.8	-11.4	-5.1	-0.7	12.0	25.9
	Az	143.6	160.1	171.7	180.0	203.3	231.1		Az	142.8	159.4	171.2	179.5	203.2	231.7
Heidelberg eL 8.7 B + 49.4	EI	27.4	32.1	33.7	34.0	31.4	20.7	Zürich eL 8.0 B + 48.5	EI	28.1	33.0	34.7	35.0	32.4	21.5
	Sk	-23.0	-12.9	-5.4	0.0	15.1	30.8		Sk	-23.9	-13.6	-5.8	-0.3	15.4	31.5
Köln eL 7.0 B + 51.0	Az	138.7	154.2	165.1	172.9	195.8	224.4	Zürich eL 8.0 B + 48.5	Az	140.1	156.2	167.8	176.0	198.7	228.3
	EI	22.8	27.9	30.0	30.8	29.9	21.5		EI	26.5	31.7	33.7	34.4	32.6	22.6
Liljebäck eL 10.7 B + 53.9	Sk	-24.3	-15.7	-9.2	-4.4	9.8	25.8	Zürich eL 8.0 B + 48.5	Sk	-25.2	-15.5	-8.1	-2.7	12.9	29.7
	Az	137.8	153.3	164.2	172.0	195.0	223.8		Az	137.8	153.2	164.1	171.9	194.7	223.5
München eL 11.6 B + 48.1	EI	22.8	28.0	30.2	31.1	30.3	22.1	Zürich eL 8.0 B + 48.5	EI	22.3	27.5	29.7	30.6	29.9	21.8
	Sk	-24.9	-16.4	-9.8	-5.0	9.3	25.7		Sk	-24.6	-16.2	-8.8	-5.0	9.0	25.2

*Note: If you are missing the city you are living in, please visit <http://www.lyngsat.com/>

France

eL=East Longitude wL=West Longitude B=Latitude Az=Azimuth EI=Elevation Sk = Skew

		Turk sat	Astra 2A/2B/2D	Astra 1E-1H /1KR/2C	Hot bird 2/5/7A /8	Atlant icbird 3	Hispasat 1C,1D		Turk sat	Astra 2A/2B/2D	Astra 1E-1H /1KR/2C	Hot bird 2/5/7A /8	Atlant icbird 3	Hispasat 1C,1D	
		1C,2A	Euro bird 1	Euro bird 1	E	13.0 E	5.0 W		30.0 W	42.0 E	28.2 E	19.2 E	13.0 E	5.0 W	30.0 W
Amiens eL 2.3 B + 49.9	Az	132.8	147.8	158.3	186.1	189.5	219.5	Mulhouse eL 7.3 B + 47.7	Az	136.9	152.7	184.1	172.4	199.5	225.9
	Sk	-28.3	-20.2	-13.8	-8.9	6.1	24.2		Sk	-27.4	-18.0	-10.6	-5.1	11.0	28.9
Angers wL 0.6 B + 47.5	Az	128.7	143.3	154.0	161.9	188.0	217.4	Nancy el 6 P; R + 48.7	Az	136.2	151.7	182.9	171.0	194.8	224.3
	Sk	-31.8	-23.8	-17.2	-12.1	4.0	24.2		Sk	-27.2	-18.2	-11.2	-5.9	9.7	27.4
Anjoulema eL 0.2 B + 45.7	Az	128.6	143.3	154.3	162.3	187.2	219.1	Nantes wL 1.6 B + 47.2	Az	127.6	142.1	162.7	160.5	184.6	216.4
	Sk	-33.1	-24.7	-17.7	-12.3	5.1	26.2		Sk	-32.5	-24.7	-18.2	-13.1	3.1	23.8
Arras eL 2.8 B + 50.3	Az	133.3	148.3	159.0	166.8	190.1	219.9	Nizza wL 7.3 R + 43.7	Az	135.0	151.0	163.0	171.7	197.5	227.8
	Sk	-27.7	-19.6	-13.2	-8.4	6.4	24.2		Sk	-30.8	-20.5	-12.2	-6.0	12.6	32.4
Bayonne eL 1.5 B + 43.3	Az	128.8	143.7	155.1	163.5	189.4	221.8	Orleans eL 1.9 B + 47.9	Az	131.4	146.3	157.2	165.1	189.2	220.0
	Sk	-34.6	-25.5	-17.9	-12.0	6.9	29.0		Sk	-30.2	-21.8	-15.1	-9.9	6.2	25.5
Belfort eL 6.8 B + 47.8	Az	136.4	152.1	163.5	171.7	195.8	225.4	Paris eL 2.3 B + 48.9	Az	132.2	147.2	158.1	166.0	189.7	220.0
	Sk	-27.7	-18.4	-11.1	-5.8	10.6	28.7		Sk	-29.2	-20.9	-14.2	-9.2	6.3	25.0
Bordeaux wL 0.6 B + 44.8	Az	127.5	142.1	153.0	161.1	186.3	218.7	Quimper wL 4.2; B + 48.0	Az	125.5	139.6	149.9	157.4	181.1	213.1
	Sk	-34.2	-25.9	-18.8	-13.6	3.3	26.3		Sk	-39.0	-25.7	-19.6	-14.9	0.7	21.4
Boulogne wL 1.6 B + 50.7	Az	132.3	147.1	157.7	165.4	184.4	214.9	Reims eL 4.0 B + 49.3	Az	134.1	149.3	160.3	168.2	191.8	221.7
	Sk	-27.9	-20.1	-13.9	-9.2	2.8	21.3		Sk	-27.9	-18.4	-12.7	-7.7	7.7	25.7
Brest wL 4.5 B + 48.1	Az	125.3	139.3	149.6	157.1	180.6	212.5	Rennes wL 1.7 B + 48.1	Az	127.9	142.3	152.9	160.6	184.5	215.9
	Sk	-32.8	-25.6	-19.7	-15.0	0.4	20.9		Sk	-31.8	-24.1	-17.7	-12.8	3.0	23.0
Caen wL 0.4 B + 49.2	Az	129.7	144.3	154.8	162.6	186.1	216.9	Rouen eL 1.1 B + 49.5	Az	131.2	146.0	156.7	164.5	188.0	218.4
	Sk	-30.2	-22.5	-16.1	-11.3	4.0	29.1		Sk	-29.3	-21.3	-14.9	-10.0	5.2	23.8
Calais eL 1.9 B + 51.0	Az	132.7	147.3	158.2	165.9	188.9	218.7	St-Etienne eL 4.4 B + 45.4	Az	132.8	148.2	159.6	168.0	193.1	223.8
	Sk	-27.6	-19.8	-13.5	-8.9	5.6	23.2		Sk	-31.0	-21.7	-14.1	-8.4	9.2	29.1
Chalons-sur-Marne eL 4.3 B + 49.0	Az	134.3	149.8	160.6	168.6	192.3	222.2	St-Nazaire wL 2.2 B + 47.3	Az	127.1	141.4	151.9	159.7	183.8	215.7
	Sk	-27.6	-19.4	-12.6	-7.5	8.0	26.1		Sk	-32.8	-25.1	-18.6	-13.6	2.6	23.3
Charleville-Mazieres eL 4.7 B + 49.7	Az	135.0	150.3	161.2	169.1	192.6	222.2	St-Quentin eL 3.3 B + 49.8	Az	133.6	148.7	159.5	167.3	190.8	220.6
	Sk	-27.2	-18.7	-12.0	-7.0	8.1	25.8		Sk	-27.8	-19.6	-13.0	-8.1	7.0	24.9
Clermont-Ferrand eL 3.1 B + 45.8	Az	131.6	146.8	158.0	166.3	191.2	222.3	Strasbourg eL 7.8 B + 48.6	Az	137.8	153.6	164.9	173.0	195.8	225.9
	Sk	-31.5	-22.5	-15.1	-9.5	7.8	28.0		Sk	-25.3	-17.1	-9.9	-4.6	11.1	28.6
Colmar wL 7.3 B + 48.1	Az	137.1	152.9	164.2	172.4	196.4	225.7	Toulouse eL 1.5 B + 43.6	Az	128.9	143.8	155.1	163.5	189.3	221.6
	Sk	-27.1	-17.7	-10.5	-5.1	10.8	28.5		Sk	-34.3	-25.3	-17.8	-11.9	6.8	28.8
Epinal eL 6.5 B + 48.2	Az	136.2	151.8	163.1	171.2	195.2	224.7	Tours eL 0.7 B + 47.4	Az	129.9	144.7	155.5	163.4	187.7	218.9
	Sk	-27.5	-18.1	-11.2	-5.8	10.1	28.0		Sk	-31.3	-13.0	-16.3	-11.1	5.2	25.2
Le Havre eL 0.1 B + 49.5	Az	130.3	144.9	155.5	163.2	186.7	217.3	Verdun eL 5.4 B + 49.2	Az	135.5	150.9	162.0	170.0	193.6	223.2
	Sk	-29.7	-21.9	-15.6	-10.6	4.3	23.2		Sk	-27.3	-18.5	-11.7	-6.5	8.9	26.6
Limoges eL 1.3 B + 45.8	Az	129.8	144.7	155.7	163.8	188.7	220.2	Marseille eL 5.4 B + 43.3	Az	132.7	148.5	160.3	168.9	194.9	226.0
	Sk	-32.4	-23.8	-16.7	-11.2	6.1	26.8		Sk	-32.3	-22.4	-14.2	-8.0	10.8	31.6
Lorient wL 3.4 B + 47.8	Az	126.1	140.3	150.7	158.3	182.2	214.1	Metz eL 6.2 B + 49.1	Az	136.3	151.8	163.0	171.0	194.6	224.0
	Sk	-32.9	-25.4	-19.2	-14.4	1.5	22.1		Sk	-26.9	-18.0	-11.0	-5.9	9.6	27.1
Lyon eL 4.8 B + 45.8	Az	133.4	148.9	160.4	168.7	193.6	224.2	Montpellier eL 3.9 B + 43.6	Az	131.3	146.8	158.3	166.9	192.8	224.2
	Sk	-30.5	-21.1	-13.6	-7.9	9.4	29.0		Sk	-33.0	-23.4	-15.5	-9.5	8.2	30.4

*Note: If you are missing the city you are living in, please visit <http://www.lyngsat.com/>

Italy

eL=East Longitude wL=West Longitude B=Latitude Az=Azimuth El=Elevation Sk : Skew

	Turk sat	Astra 2A/2B/2D Euro bird 1	Astra 15-1H /1KR/ 2C	Hot bird 2/67A /8	Allianc cbird	Hispasat 3 0		Turk sat	Astra 2A/2B/2D Euro bird 1	Astra 15-1H /1KR/ 2C	Hot bird 2/67A /8	Allianc icbird	Hispasat 3 0
	1C,2A	28.2 E	19.2 E	13.0 E	5.0 W	30.0 W		1C,2A	28.2 E	19.2 E	13.0 E	5.0 W	30.0 W
Ancona eL 13.5 B + 43.6	Az 141.8 El 32.2 Sk -21.6	159.2 37.6 -14.9	171.8 39.4 -6.0	180.7 39.8 0.5	205.9 36.4 16.4	234.0 23.7 35.9	La Spezia eL 9.8 B + 44.1	Az 137.9 El 29.9 Sk -28.8	154.5 35.9 -18.0	166.7 38.3 -9.5	175.5 39.0 -3.3	200.8 37.0 14.8	230.1 25.1 33.5
Arezzo eL 11.8 B + 43.5	Az 139.8 El 31.5 Sk -27.9	156.9 37.2 -16.6	169.4 39.3 -7.7	178.3 38.9 -1.2	203.7 37.1 16.9	232.5 24.9 35.1	Lecco eL 18.2 B + 40.3	Az 145.7 El 37.3 Sk -25.5	164.7 42.2 -11.6	178.4 43.4 -1.2	189.0 43.1 6.1	213.5 37.6 24.9	239.9 22.5 41.3
Asciano eL 11.5 B + 43.2	Az 139.3 El 31.5 Sk -28.4	156.4 37.4 -17.0	168.9 39.5 -8.1	177.9 40.1 -1.6	203.4 37.4 16.8	232.3 25.2 35.2	Livorno eL 10.3 B + 43.5	Az 138.1 El 30.6 Sk -29.0	154.9 36.7 -18.0	167.2 39.1 -9.3	175.1 39.8 -2.8	201.7 37.5 15.5	230.9 25.8 34.3
Ascoli Piceno eL 13.6 B + 42.9	Az 141.5 El 32.9 Sk -27.1	159.0 38.4 -15.2	171.7 40.2 -6.0	180.8 40.6 0.6	206.3 37.1 18.9	234.4 24.2 36.6	Milano eL 9.2 B + 45.5	Az 137.9 El 28.5 Sk -28.0	154.2 34.4 -17.8	166.1 36.8 -9.7	174.7 37.5 -2.8	199.5 35.8 13.6	230.8 25.1 31.8
Ascoli Satriano eL 15.5 B + 41.2	Az 142.9 El 36.3 Sk -27.0	161.2 40.7 -14.1	174.4 42.3 -4.2	183.0 42.3 2.9	209.6 38.0 21.8	237.1 23.9 39.2	Napoli eL 14.3 B + 40.8	Az 141.2 El 34.9 Sk -28.3	159.2 40.7 -15.6	172.5 42.6 -3.7	181.9 42.8 1.5	206.1 38.8 21.0	236.1 24.9 39.0
Bari eL 15.9 B + 41.1	Az 144.5 El 36.0 Sk -25.9	163.1 41.1 -12.7	176.5 42.4 -2.7	185.9 42.3 4.4	211.4 37.5 23.2	238.4 23.0 39.9	Padova eL 11.6 B + 45.3	Az 140.5 El 29.8 Sk -26.6	157.2 35.3 -15.8	169.4 37.3 -7.5	178.0 37.8 -1.4	202.8 35.3 15.8	231.3 23.8 33.6
Barletta eL 15.3 B + 41.3	Az 143.9 El 35.5 Sk -28.3	162.3 40.7 -13.2	175.6 42.2 -3.3	185.0 42.1 -1.7	210.5 37.5 22.5	237.7 23.3 39.5	Palermog eL 13.4 B + 38.1	Az 138.5 El 36.7 Sk -31.4	156.6 43.2 -18.1	170.6 45.4 -7.4	180.8 45.8 0.5	206.3 41.8 21.9	236.8 27.1 41.2
Bergamo eL 9.7 B + 45.7	Az 139.5 El 28.5 Sk -27.5	154.9 34.3 -17.2	166.8 36.5 -9.2	175.3 37.3 -3.2	200.1 35.4 13.9	229.2 24.6 31.9	Parma eL 10.3 B + 44.8	Az 138.8 El 29.6 Sk -27.9	155.4 35.4 -17.2	167.5 37.7 -8.8	173.2 38.3 -2.7	201.3 38.1 14.9	230.3 24.8 34.8
Bologna eL 11.3 B + 44.5	Az 139.8 El 30.4 Sk -27.5	156.6 36.0 -16.5	168.8 38.1 -7.9	177.6 38.7 -1.7	202.7 36.2 15.9	231.4 24.5 33.9	Pavia eL 9.2 B + 45.2	Az 137.7 El 28.7 Sk -28.3	154.1 34.7 -18.0	166.0 37.1 -9.8	174.6 37.9 -3.8	199.6 36.1 13.7	229.0 25.3 32.1
Bolzano eL 11.3 B + 46.5	Az 140.7 El 28.7 Sk -25.9	157.3 34.0 -15.4	169.2 36.0 -7.4	177.7 36.5 -1.6	202.0 34.2 14.9	230.5 23.1 32.1	Pesaro eL 12.9 B + 43.9	Az 141.2 El 31.6 Sk -26.8	158.5 37.1 -15.3	170.9 39.0 -6.5	179.8 39.4 -0.1	204.9 36.3 17.7	233.2 23.9 35.3
Brescia eL 10.3 B + 45.5	Az 139.1 El 29.0 Sk -27.3	155.6 34.7 -16.8	167.6 36.9 -8.6	176.2 37.6 -2.6	201.0 35.5 14.5	229.9 24.9 32.4	Pescara eL 14.2 B + 42.5	Az 142.0 El 33.5 Sk -27.0	158.8 39.0 -14.8	172.6 40.7 -5.4	181.8 41.0 1.3	207.3 37.2 19.7	235.2 24.0 37.3
Castelli eL 9.1 B + 39.3	Az 134.4 El 33.3 Sk -33.6	151.3 40.4 -31.8	164.3 43.4 -19.1	173.9 44.4 -4.7	201.7 42.3 16.6	232.1 29.6 37.4	Piacenza eL 9.6 B + 45.0	Az 138.1 El 29.1 Sk -28.2	154.6 35.0 -17.7	166.5 37.3 -9.5	175.2 38.1 -3.4	200.2 36.2 14.2	237.5 25.2 39.5
Campi eL 10.9 B + 44.8	Az 139.4 El 29.9 Sk -27.5	156.1 35.6 -15.8	169.3 37.8 -5.8	177.0 38.4 1.4	202.0 36.0 15.4	230.8 24.6 33.4	Pisa eL 10.4 B + 43.7	Az 138.3 El 30.5 Sk -28.7	155.1 36.5 -17.7	167.3 38.8 -9.1	175.2 39.5 -2.7	201.7 37.3 15.5	230.9 25.6 34.2
Carrara eL 10.1 B + 44.1	Az 138.2 El 30.1 Sk -28.6	154.9 36.1 -17.8	167.1 38.4 -9.3	175.9 39.1 -3.0	201.2 37.0 15.1	230.5 25.5 33.6	Roma eL 12.5 B + 41.9	Az 139.7 El 33.1 Sk -28.8	157.2 39.1 -16.8	170.0 41.2 -7.4	179.3 41.6 -0.6	205.3 38.4 18.5	233.9 25.5 37.0
Catania eL 15.1 B + 37.5	Az 140.2 El 36.2 Sk -30.5	159.0 44.4 -16.5	173.2 46.3 -5.4	183.4 46.5 2.7	211.0 41.7 24.1	238.7 26.3 42.7	Taranto eL 17.2 B + 40.5	Az 144.5 El 36.7 Sk -26.2	163.3 41.8 -12.6	176.9 43.1 -2.4	185.4 43.0 4.9	212.1 37.9 23.9	239.0 23.1 40.7
Catanzaro eL 16.6 B + 38.9	Az 142.9 El 37.8 Sk -28.0	161.9 43.4 -14.0	175.9 44.9 -3.2	185.8 44.8 4.5	212.3 39.7 24.5	239.3 24.4 42.0	Torino eL 7.7 B + 45.1	Az 136.0 El 28.0 Sk -29.3	152.1 34.2 -19.3	163.9 36.9 -11.3	172.5 37.8 -5.3	197.6 36.6 12.4	227.5 26.2 31.4
Cosaro eL 14.6 B + 37.8	Az 139.8 El 37.7 Sk -30.7	158.5 43.9 -16.8	172.6 45.9 -5.9	182.7 46.1 2.1	210.2 41.6 23.4	238.1 26.4 42.2	Trento eL 11.1 B + 46.1	Az 140.3 El 28.9 Sk -26.3	156.9 34.4 -15.8	168.9 36.4 -7.7	177.4 37.0 -1.8	201.9 34.6 14.9	230.5 23.5 32.3
Cesena eL 12.2 B + 44.2	Az 140.6 El 31.1 Sk -27.1	157.7 36.7 -15.8	170.0 38.6 -7.1	178.9 39.1 -0.8	204.0 36.3 16.9	232.5 24.2 34.6	Trieste eL 13.7 B + 45.6	Az 143.0 El 30.6 Sk -24.9	160.1 35.6 -13.8	172.3 37.2 -5.4	181.0 37.5 0.7	205.3 34.3 17.4	233.2 22.4 34.0
Cosenza eL 16.2 B + 38.3	Az 142.7 El 37.3 Sk -28.0	161.5 42.9 -14.2	175.3 44.4 -3.6	185.1 44.4 3.9	211.5 39.5 23.8	238.8 24.5 41.4	Venezia eL 12.3 B + 45.4	Az 141.4 El 30.1 Sk -26.0	158.2 35.4 -15.1	170.4 37.3 -6.7	179.1 37.7 -0.6	203.7 34.9 16.3	232.0 23.3 33.6
Ferrara eL 11.6 B + 44.8	Az 140.2 El 30.2 Sk -27.0	157.1 35.8 -16.1	169.3 37.8 -7.6	178.0 38.4 -1.4	202.9 35.8 16.1	231.6 24.1 33.8	Verona eL 11.0 B + 45.3	Az 139.8 El 29.5 Sk -27.0	156.5 35.1 -16.3	169.5 37.2 -8.0	177.2 37.8 -2.0	202.0 35.5 11.6	230.7 24.1 33.0
Firenze eL 11.3 B + 43.8	Az 139.3 El 30.9 Sk -28.0	156.2 36.7 -16.9	168.6 38.9 -8.2	177.5 39.5 -1.8	202.9 36.9 16.3	231.7 25.0 34.5	Venise eL 12.2 B + 45.3	Az 141.1 El 30.1 Sk -26.2	158.0 35.5 -15.3	170.2 37.4 -8.9	178.9 37.8 -0.8	203.5 35.1 16.3	231.9 23.4 33.6

*Note: If you are missing the city you are living in, please visit <http://www.lyngsat.com/>

Spain

eL=East Longitude wL=West Longitude B=Latitude Az=Azimuth El=Elevation Sk = Skew

	Turk sat	Astra 2A/2B/2D		Astra 1E/1H/1K/R/2C		Hot bird 2/6/7A/8		Atlant icbird 3		Hispa sat 1C,1D			Turk sat	Astra 2A/2B/2D		Astra 1E/1H/1K/R/2C		Hot bird 2/6/7A/8		Atlant icbird 3		Hispa sat 1C,1D		
		1C,2A	Euro bird 1	1C,2A	Euro bird 1	1C,2A	Euro bird 1	1C,2A	Euro bird 1	1C,2A	Euro bird 1			1C,2A	Euro bird 1	1C,2A	Euro bird 1	1C,2A	Euro bird 1	1C,2A	Euro bird 1	1C,2A	Euro bird 1	1C,2A
		42.0 E	26.2 E	19.2 E	13.0 E	5.0 W	30.0 W						42.0 E	26.2 E	19.2 E	13.0 E	5.0 W	30.0 W						
Albacete wL 1.8 B + 39.0	Az	123.2	137.4	149.6	157.2	185.0	220.4	La Coruña wL 8.4 B + 43.3	Az	119.5	132.7	142.7	150.3	175.0	210.0									
	El	26.3	35.2	39.8	42.3	44.7	36.3		El	19.5	29.1	32.9	35.6	39.9	35.5									
	Sk	-40.5	-31.7	-23.9	-17.5	3.9	30.3		Sk	-39.3	-32.3	-26.2	-21.2	-3.6	21.3									
Algeciras wL 5.5 B + 36.2	Az	118.4	-37.2	142.1	150.5	179.2	217.7	Las Palmas wL 15.4 B + 28.1	Az	106.8	116.3	124.3	131.0	158.7	208.9									
	El	26.2	35.1	40.6	43.7	48.1	40.7		El	20.2	32.3	39.9	44.7	55.2	53.5									
	Sk	-45.2	-37.2	-29.7	-23.4	-0.7	29.5		Sk	-57.6	-52.3	-46.8	-41.8	-18.7	25.3									
Alicante wL 0.5 B + 38.1	Az	124.1	138.6	150.0	158.9	187.2	222.3	Madrid wL 3.7 B + 40.1	Az	122.3	136.2	146.9	155.1	182.0	217.3									
	El	27.6	36.5	41.0	43.4	45.3	36.0		El	24.2	33.0	37.7	40.2	43.3	36.0									
	Sk	-40.4	-31.2	-23.1	-16.4	5.7	31.9		Sk	-40.1	-31.8	-24.6	-18.6	1.5	27.5									
Almeria wL 2.5 B + 36.9	Az	121.4	135.4	146.5	155.3	184.2	221.0	Málaga wL 4.4 B + 36.7	Az	119.6	133.1	143.8	152.3	181.0	218.7									
	El	27.1	36.5	41.6	44.2	47.2	38.4		El	25.7	35.4	40.7	43.6	47.4	39.6									
	Sk	-43.0	-34.2	-26.2	-19.6	3.3	31.6		Sk	-44.2	-35.9	-28.2	-21.9	0.8	30.1									
Ávila wL 4.7 B + 40.7	Az	121.5	135.2	145.8	153.9	180.4	215.9	Palma de Mallorca eL 2.7 B + 39.6	Az	127.9	143.1	155.0	164.0	191.9	225.2									
	El	23.4	32.2	37.0	39.6	43.0	36.3		El	29.0	37.1	41.1	43.0	45.5	33.2									
	Sk	-40.2	-32.3	-25.3	-19.5	0.4	26.4		Sk	-37.4	-27.6	-19.0	-12.3	9.2	33.2									
Badajoz wL 7.0 B + 36.8	Az	118.6	131.7	141.9	149.9	176.8	214.1	Salamanca wL 5.7 B + 41.0	Az	120.9	134.3	144.8	152.8	179.0	214.6									
	El	22.7	32.2	37.5	40.5	45.0	39.1		El	22.6	31.4	36.3	38.9	42.7	36.5									
	Sk	-43.2	-35.6	-28.7	-23.0	-2.5	25.9		Sk	-40.4	-32.7	-25.8	-20.2	-0.6	25.3									
Barcelona eL 2.2 B + 41.4	Az	128.4	143.6	155.2	169.9	190.6	223.6	San Sebastian wL 2.0 B + 43.3	Az	125.4	139.7	150.5	158.7	184.4	217.8									
	El	27.5	35.3	39.1	40.9	41.6	32.1		El	23.6	31.6	35.7	37.8	40.0	32.7									
	Sk	-36.0	-26.5	-18.4	-12.3	8.1	31.2		Sk	-36.4	-28.1	-21.0	-15.3	3.2	26.5									
Dilbao wL 2.9 B + 43.3	Az	124.5	138.6	149.3	157.4	183.0	216.7	Santa Cruz de la Palma wL 17.8 B + 28.7	Az	105.5	114.9	122.5	128.9	154.7	204.3									
	El	23.1	31.1	35.4	37.6	40.1	33.2		El	18.0	30.1	37.6	42.5	53.7	53.9									
	Sk	-36.8	-28.8	-21.8	-16.3	2.2	25.8		Sk	-57.7	-52.7	-47.7	-43.1	-22.0	21.1									
Burocos wL 3.7 B + 42.4	Az	123.3	137.3	147.9	156.0	182.0	216.3	Santa Cruz de Tenerife wL 16.3 B + 28.5	Az	106.4	115.9	123.8	130.4	157.3	207.2									
	El	23.1	31.5	35.9	38.3	41.1	34.3		El	19.4	31.5	39.0	43.8	54.5	53.5									
	Sk	-38.1	-30.1	-23.1	-17.5	1.4	25.9		Sk	-57.5	-52.3	-46.9	-42.0	-19.8	23.6									
Cadiz wL 6.3 B + 36.5	Az	117.9	130.8	141.2	149.5	177.8	216.4	Santander wL 3.9 B + 43.5	Az	123.7	137.7	148.3	156.2	181.7	215.5									
	El	24.4	34.3	39.8	43.0	47.6	40.9		El	22.3	30.5	34.8	37.1	39.9	33.4									
	Sk	-45.3	-37.5	-30.2	-24.1	-1.8	28.5		Sk	-37.1	-29.3	-22.5	-17.0	1.2	24.9									
Cartagena wL 1.0 B + 37.6	Az	123.2	137.6	149.0	157.8	186.6	222.3	Sevilla wL 5.0 B + 37.4	Az	118.7	131.8	142.2	150.4	178.4	216.3									
	El	27.7	36.8	41.5	44.0	46.2	36.9		El	24.2	33.9	39.3	42.3	46.7	39.9									
	Sk	-41.5	-32.3	-24.1	-17.4	5.2	32.2		Sk	-44.2	-36.3	-29.1	-23.1	-1.3	28.0									
Cordoba wL 4.8 B + 37.8	Az	119.9	133.3	144.0	152.3	180.3	217.5	Valencia wL 0.7 B + 39.3	Az	124.5	139.0	150.3	159.5	186.8	221.6									
	El	24.8	34.3	39.5	42.3	46.2	38.9		El	26.9	35.6	40.0	42.3	44.3	35.3									
	Sk	-43.2	-35.1	-27.7	-21.5	0.0	26.8		Sk	-39.6	-30.2	-22.1	-15.7	5.2	30.9									
Gijón wL 5.5 B + 43.7	Az	122.1	135.7	146.0	154.8	179.0	213.2	Valladolid wL 4.7 B + 41.6	Az	122.0	135.7	146.3	154.3	180.4	215.4									
	El	21.1	29.4	33.9	36.4	39.8	34.2		El	22.8	31.5	36.1	38.6	41.9	35.5									
	Sk	-37.9	-30.4	-23.9	-18.7	-0.7	-0.7		Sk	-39.3	-31.5	-24.5	-18.9	0.3	25.7									
Granada wL 3.6 B + 37.2	Az	120.8	134.3	145.2	153.8	182.3	219.4	Vigo wL 8.7 B + 42.2	Az	118.8	131.8	141.8	149.4	174.5	210.2									
	El	26.1	35.6	40.7	43.5	46.9	39.8		El	19.8	29.7	33.7	36.5	41.1	36.7									
	Sk	-43.3	-34.8	-27.1	-20.6	1.8	30.4		Sk	-40.5	-33.5	-27.3	-22.4	-4.1	21.8									
Hospital de Llobregat eL 7.1 B + 41.4	Az	128.3	143.4	155.0	163.7	190.7	223.5	Zaragoza wL 1.0 B + 41.6	Az	125.4	139.9	151.0	159.4	188.0	219.9									
	El	27.5	35.3	39.1	40.9	41.7	32.1		El	25.3	33.5	37.7	39.9	41.8	33.8									
	Sk	-36.0	-26.6	-18.6	-12.1	8.0	31.1		Sk	-37.5	-28.7	-21.7	-15.1	4.5	28.6									
Ibiza eL 1.4 B + 38.9	Az	126.3	141.2	153.0	161.9	190.2	224.2																	
	El	28.6	37.1	41.3	43.4	44.5	34.5																	
	Sk	-38.9	-29.1	-20.7	-13.9	7.9	32.9																	

*Note: If you are missing the city you are living in, please visit <http://www.lyngsat.com/>

Switzerland

eL=East Longitude wL=West Longitude B=Latitude Az=Azimuth El=Elevation Sk : Skew

		Turk sat	Astra 2A/2B/2D	Astra 1E-1H /1KR/ 2C	Hot bird 2/5/7A /B	Atlanticbrd 3	Hispasat 1C,1D
		1C,2A	Euro bird 1				
		42.0 E	28.2 E	19.2 E	13.0 E	5.0 W	30.0 W
Basel eL 7.6 B + 47.6	Az	137.1	153.0	164.5	172.7	196.9	226.2
	El	26.0	31.8	34.2	35.1	34.0	24.4
	Sk	-27.3	-17.8	-10.4	-4.9	11.3	29.1
Bern eL 7.4 B + 47.0	Az	136.7	152.6	164.1	172.4	196.8	226.3
	El	26.4	32.3	34.8	35.8	34.7	25.0
	Sk	-27.9	-18.3	-10.8	-5.2	11.3	29.5
Biel eL 8.2 B + 46.5	Az	137.3	153.4	165.0	173.4	198.0	227.4
	El	27.2	33.1	35.5	36.4	35.0	24.9
	Sk	-27.8	-18.0	-10.3	-4.5	12.2	30.4
	Az	135.0	150.7	162.2	170.6	195.3	225.3
	El	26.3	32.6	35.3	36.4	35.7	26.2
Genève eL 6.2 B + 46.2	Sk	-29.3	-19.8	-12.2	-6.5	10.6	29.5
	Az	136.7	152.5	164.1	172.4	196.8	226.3
	El	26.4	32.3	34.8	35.8	34.7	25.0
König eL 7.4 B + 46.9	Sk	-28.0	-18.4	-10.8	-5.2	11.4	29.6
	Az	135.7	151.4	162.9	171.3	195.9	225.7
	El	26.4	32.5	35.1	36.1	35.3	25.7
Lausanne eL 6.7 B + 46.5	Sk	-28.7	-19.2	-11.6	-6.0	10.9	29.6
	Az	137.8	154.0	165.7	174.2	198.8	228.1
	El	27.7	33.6	35.9	36.7	35.2	24.8
Locarno eL 8.8 B + 46.2	Sk	-27.7	-17.7	-9.8	-4.0	12.9	31.0
	Az	137.2	153.2	164.7	173.1	197.4	226.8
	El	26.6	32.4	34.8	35.7	34.5	24.6
Luzern eL 7.9 B + 47.0	Sk	-27.6	-17.9	-10.4	-4.7	11.8	29.8
	Az	139.0	155.2	166.8	175.1	199.2	228.1
	El	27.0	32.5	34.7	35.4	33.7	23.6
Sankt Gallen eL 9.4 B + 47.4	Sk	-26.4	-16.5	-8.9	-3.3	12.9	30.3
	Az	136.8	152.8	164.3	172.7	197.1	226.6
	El	26.7	32.6	35.0	36.0	34.8	25.0
Thun eL 7.8 B + 46.8	Sk	-28.0	-18.3	-10.7	-5.1	11.6	29.8
	Az	138.4	154.4	166.0	174.2	198.4	227.4
	El	26.6	32.2	34.5	35.3	33.8	23.9
Winterthur eL 8.8 B + 47.5	Sk	-26.7	-16.9	-9.4	-3.8	12.3	29.9
	Az	138.1	154.1	165.7	174.0	198.1	227.3
	El	26.6	32.3	34.6	35.4	34.0	24.0
Zürich eL 8.6 B + 47.4	Sk	29.6	-17.1	-9.6	-4.0	12.2	29.8

*Note: If you are missing the city you are living in, please visit <http://www.lyngsat.com/>

Norway

eL=East Longitude wL=West Longitude B=Latitude Az=Azimuth El=Elevation

		Tuerksat 1C,2A	ASTRA Eurobird 1	ASTRA 1D/3A	ASTRA 1E -	Eutelsat W2	Hotbird 2/6/7A/B	Eutelsat W1	Eutelsat W3A	Intelsat Thor 2 - 3	Atlantid Bird 3	HISPASA T 1C,1D
		42.0 East	28.2 East	23.5 East	19.2 East	16.0 East	13.0 East	10.0 East	7.0 East	1.0 West	5.0 West	30.0 West
Bergen eL 5.3; B + 60.4	Az: El: Sk:	139.4 15.0 -18.8	154.1 18.9 -12.5	159.3 19.8 -10.1	164.1 20.5 -7.8	167.6 20.9 -6.0	171.2 21.2 -4.4	174.6 21.4 -2.7	178.1 21.5 -1.0	187.3 21.3 3.6	191.8 21.0 5.8	219.2 15.4 18.2
Drammen eL 10.3; B + 59.8	Az: El: Sk:	144.4 17.0 -17.0	159.4 20.5 -10.1	164.8 21.2 -7.6	169.7 21.8 -5.2	173.4 21.8 -3.3	176.8 22.0 -1.6	180.3 22.2 0.2	183.8 22.2 1.9	193.0 21.5 6.5	197.5 21.0 8.7	224.4 14.2 20.6
Kristiansand eL 8.0; B + 58.1	Az: El: Sk:	141.6 17.7 -19.2	156.6 21.6 -12.1	161.9 22.6 -9.4	166.9 23.2 -6.9	169.9 23.6 -5.0	170.6 23.8 -3.1	174.1 23.9 -1.2	177.7 23.9 0.6	181.2 23.5 5.6	190.6 23.0 8.0	222.6 16.2 21.0
Oslo eL 10.8; B + 59.9	Az: El: Sk:	145.0 17.1 -18.7	160.0 20.4 -9.8	165.4 21.2 -7.3	170.3 21.7 -4.8	173.9 21.9 -3.0	177.4 22.0 -1.3	180.9 22.0 0.5	184.3 22.0 2.2	193.5 21.3 6.8	198.1 20.7 9.0	224.9 13.9 20.8
Stavanger eL 5.8; B + 59.0	Az: El: Sk:	139.4 16.2 -19.5	154.3 20.3 -12.9	159.6 21.3 -10.4	164.4 22.0 -7.9	168.1 22.5 -6.1	171.6 22.8 -4.3	175.0 22.9 -2.5	178.5 23.0 -0.7	187.9 22.8 4.1	192.5 22.4 6.4	220.0 16.4 19.4
Tromsø eL 10.4; B + 69.6	Az: El: Sk:	145.5 13.6 -14.6	160.3 16.7 -8.6	165.4 17.4 -6.4	170.2 17.8 -4.3	173.7 18.0 -2.8	177.1 18.1 -1.3	180.4 18.1 0.2	183.8 18.1 1.7	192.7 17.6 5.6	197.1 17.1 7.5	223.5 11.3 17.8

*Note: If you are missing the city you are living in, please visit <http://www.lyngsat.com/>

Denmark

eL=East Longitude wL=West Longitude B=Latitude Az=Azimuth El=Elevation

		Tuerksat 1C,2A	ASTRA Eurobird 1	ASTRA 1D/3A	ASTRA 1E -	Eutelsat W2	Hotbird 2/6/7A/B	Eutelsat W1	Eutelsat W3A	Intelsat Thor 2 - 3	Atlantid Bird 3	HISPASA T 1C,1D
		42.0 East	28.2 East	23.5 East	19.2 East	16.0 East	13.0 East	10.0 East	7.0 East	1.0 West	5.0 West	30.0 West
Alborg eL 59.9; B + 57.1	Az: El: Sk:	143.3 19.3 -19.0	158.5 23.1 -11.5	163.9 23.3 -8.7	169.0 24.6 -6.0	172.8 24.9 -3.9	176.3 25.0 -2.0	179.9 25.1 -0.1	183.5 25.0 1.9	193.0 24.4 7.0	197.6 23.8 9.4	224.9 16.3 22.5
Aarhus eL 10.2; B + 56.2	Az: El: Sk:	143.3 20.1 -19.4	158.7 24.1 -11.7	164.1 24.9 -8.8	169.2 25.5 -6.0	173.0 25.8 -3.9	176.7 26.0 -1.9	180.3 26.0 0.1	183.9 26.0 2.1	193.4 25.3 7.4	198.1 24.6 10.0	225.5 16.9 23.4
Esbjerg eL 8.5; B + 55.5	Az: El: Sk:	141.2 20.0 -20.8	157.7 24.3 -13.0	163.2 25.3 -10.1	168.3 26.0 -7.3	172.1 26.4 -5.1	175.8 26.7 -3.1	179.4 26.8 -1.0	183.0 26.8 1.0	192.7 26.2 6.5	197.4 25.6 9.1	225.0 18.1 23.2
Helsingør eL 12.6; B + 56.1	Az: El: Sk:	145.8 21.0 -18.3	161.4 24.7 -10.2	166.9 25.4 -7.2	172.1 25.8 -4.4	175.9 26.1 -2.3	179.6 26.2 -0.3	183.2 26.1 1.8	186.8 26.0 3.8	196.3 25.0 9.0	201.0 24.2 11.5	228.0 15.9 24.5
Horsens eL 10.1; B + 57.1	Az: El: Sk:	143.5 19.3 -18.9	158.8 23.1 -11.4	164.2 24.0 -8.5	169.2 24.5 -5.0	173.0 24.8 -3.8	176.8 25.0 -1.9	180.1 25.0 0.1	183.7 25.0 2.0	193.2 24.3 7.1	197.8 23.7 9.8	225.1 16.2 22.6
København eL 12.6; B + 55.7	Az: El: Sk:	145.7 21.3 -18.5	161.3 25.0 -10.4	166.9 25.9 -7.4	172.0 26.3 -4.5	175.8 26.5 -2.3	179.5 26.6 -0.3	183.1 26.5 1.8	186.7 26.4 3.8	196.3 25.4 9.1	201.0 24.6 11.7	228.0 16.2 24.8
København eL 9.5; B + 55.5	Az: El: Sk:	142.3 20.4 -20.3	157.7 24.6 -12.4	163.2 25.5 -9.4	168.3 26.2 -6.6	172.1 26.5 -4.5	175.8 26.7 -2.4	179.4 26.8 -0.3	183.0 26.7 1.7	192.7 26.1 7.1	197.4 25.4 9.8	225.0 17.7 23.6
Odense eL 10.4; B + 55.4	Az: El: Sk:	143.2 20.8 -19.9	158.7 24.9 -11.9	164.2 25.8 -8.9	169.4 26.4 -6.0	173.2 26.7 -3.9	176.9 26.8 -1.8	180.5 26.9 0.3	184.1 26.9 2.3	193.8 26.0 7.8	198.5 25.3 10.4	226.0 17.3 24.1
Randers eL 10.1; B + 56.5	Az: El: Sk:	143.2 19.8 -19.3	158.5 23.7 -11.6	164.1 24.8 -8.7	169.1 25.2 -6.0	172.9 25.5 -3.9	176.5 25.7 -1.9	180.1 25.7 0.1	183.7 25.7 2.1	193.2 25.0 7.3	197.9 24.3 9.8	225.2 16.7 23.1
Roskilde eL 12.1; B + 55.7	Az: El: Sk:	145.2 21.2 -19.3	160.8 25.0 -11.6	166.3 25.7 -8.7	171.4 26.3 -6.0	175.3 26.5 -3.9	179.9 26.6 -1.9	182.6 26.6 0.2	186.2 26.4 1.7	195.8 25.5 5.6	200.5 24.8 7.5	227.6 16.4 17.8

*Note: If you are missing the city you are living in, please visit <http://www.lyngsat.com/>

Austria

eL=East Longitude wL=West Longitude B=Latitude Az=Azimuth El=Elevation

		Tuerksat IC,2A	ASTRA Eurobird 1	ASTRA ID,3A	ASTRA 1E	Eutelsat W2	Hotbird 26/7A/B	Eutelsat W1	Eutelsat W3A	Intelsat Thor 2 - 3	Atlantic Bird 3	HISPASAT IC, 1D
		42.0 East	29.2 East	23.6 East	19.2 East	16.0 East	13.0 East	10.0 East	7.0 East	1.0 West	5.C West	30.0 West
Amstetten eL 14.9; B + 48.1	Az:	145.4	162.3	168.5	174.2	178.5	182.5	186.5	190.5	200.9	205.9	233.2
	El:	28.8	33.3	34.1	34.6	34.7	34.7	34.6	34.2	32.7	31.5	20.1
	Sk:	-22.2	-11.7	-7.6	-3.9	-1.0	1.7	4.4	7.0	13.8	17.0	32.4
Attornoo eL 13.5; B + 47.9	Az:	143.8	160.6	166.6	172.4	176.7	180.7	184.8	188.8	199.3	204.3	232.0
	El:	28.5	33.2	34.1	34.7	34.9	35.0	34.9	34.6	33.2	32.1	21.0
	Sk:	-23.3	-12.9	-8.9	-5.1	-2.3	0.5	3.2	5.8	12.8	16.0	31.9
Bad Ischl eL 13.6; B + 47.7	Az:	143.9	160.7	166.7	172.5	176.8	180.9	184.9	188.9	199.4	204.5	232.2
	El:	28.7	33.4	34.4	34.9	35.1	35.2	35.1	34.8	33.4	32.3	21.0
	Sk:	-23.4	-12.9	-8.9	-5.1	-2.2	0.6	3.3	6.0	12.9	16.2	32.1
Bader eL 16.2; B + 48.0	Az:	147.0	164.1	170.2	176.0	180.3	184.3	188.3	192.3	202.6	207.6	234.5
	El:	29.5	33.6	34.1	34.8	34.9	34.8	34.5	34.1	32.1	31.2	19.4
	Sk:	21.4	10.6	6.5	2.7	0.2	2.9	5.6	8.2	14.9	18.0	33.0
Bludenz eL 9.8; B + 47.2	Az:	139.4	155.6	161.6	167.3	171.6	175.7	179.8	183.9	194.6	199.9	228.7
	El:	27.4	32.9	34.1	35.0	35.5	35.7	35.8	35.7	34.8	33.9	23.5
	Sk:	-26.3	-16.3	-12.4	-8.6	-5.7	-3.0	-0.2	2.6	9.8	13.3	30.7
Braunau eL 13.1; B + 48.3	Az:	143.4	160.1	166.2	171.8	176.0	180.1	184.1	188.1	198.5	203.6	231.4
	El:	28.0	32.7	33.6	34.3	34.5	34.6	34.5	34.3	33.0	31.9	21.0
	Sk:	-23.3	-13.1	-9.1	-5.4	-2.6	0.1	2.8	5.4	12.3	15.5	31.3
Droogrz eL 9.7; B + 47.5	Az:	139.4	155.8	161.8	167.2	171.5	175.5	179.6	183.7	194.4	199.6	228.4
	El:	27.1	32.5	33.8	34.6	35.1	35.3	35.4	35.4	34.4	33.6	23.3
	Sk:	-26.1	-16.2	-12.3	-8.6	-5.7	-3.0	-0.3	2.5	9.7	13.1	30.3
Bruck eL 16.8; B + 48.0	Az:	147.6	164.8	171.0	176.8	181.1	185.1	189.1	193.1	203.3	208.3	235.1
	El:	29.7	33.8	34.5	34.8	34.9	34.7	34.5	34.1	32.2	31.0	19.1
	Sk:	-21.0	-10.1	-6.0	-2.2	0.7	3.4	6.1	8.7	15.4	18.5	33.3
Daulslandstaz eL 15.2; B + 46.8	Az:	145.3	162.5	168.7	174.6	178.9	183.1	187.2	191.2	201.8	206.8	234.1
	El:	30.2	34.7	35.6	36.0	36.2	36.1	35.9	35.6	33.9	32.6	20.7
	Sk:	-23.0	-11.9	-7.7	-3.8	-0.8	2.1	4.9	7.6	14.7	18.0	33.7
Donaus eL 15.1; B + 47.4	Az:	145.4	162.4	168.7	174.4	178.7	182.9	186.9	190.9	201.4	206.4	233.7
	El:	29.6	34.1	34.9	35.4	35.6	35.5	35.4	35.0	33.4	32.2	20.4
	Sk:	-22.6	-11.8	-7.7	-3.8	-0.8	1.9	4.7	7.4	14.3	17.5	33.1
Dornbirn eL 9.8; B + 47.4	Az:	139.4	155.6	161.7	167.3	171.5	175.8	179.7	183.7	194.5	199.7	228.5
	El:	27.2	32.6	33.9	34.7	35.2	35.4	35.5	35.5	34.5	33.6	23.4
	Sk:	-26.1	-16.2	-12.3	-8.5	-5.7	-2.8	-0.2	2.6	9.8	13.2	30.5
Ebensee eL 13.8; B + 47.8	Az:	144.1	160.8	167.0	172.7	177.0	181.0	185.1	189.1	199.6	204.6	232.3
	El:	28.7	33.3	34.3	34.8	35.1	35.1	35.0	34.7	33.3	32.1	20.9
	Sk:	-23.2	-12.7	-8.7	-4.9	-2.0	0.7	3.4	6.1	13.0	16.3	32.1
Eisenaz eL 14.9; B + 47.5	Az:	145.3	162.2	168.4	174.2	178.5	182.6	186.6	190.7	201.1	206.1	233.5
	El:	29.4	33.9	34.8	35.2	35.4	35.4	35.2	34.9	33.2	32.1	20.4
	Sk:	-22.7	-11.9	-7.8	-3.9	-1.0	1.7	4.5	7.2	14.1	17.3	32.9
Eisenstadt eL 16.5; B + 47.5	Az:	147.1	164.3	170.5	176.3	180.7	184.7	188.8	192.8	203.2	208.1	235.0
	El:	30.1	34.2	35.0	35.4	35.4	35.3	35.1	34.6	32.8	31.6	19.5
	Sk:	-21.5	-10.5	-6.4	-2.5	0.5	3.2	5.9	8.6	15.4	18.6	33.6
Feldbach eL 15.9; B + 47.0	Az:	146.1	163.9	169.7	175.4	179.8	183.9	188.0	192.1	202.5	207.5	234.7
	El:	30.3	34.7	35.5	35.9	36.0	36.0	35.7	35.3	33.6	32.3	20.2
	Sk:	-22.3	-11.2	-7.0	-3.1	-0.1	2.7	5.5	8.2	15.2	18.4	33.8
Fohnedz eL 14.7; B + 47.2	Az:	144.8	161.8	168.1	173.8	178.2	182.3	186.3	190.4	200.9	206.0	233.4
	El:	29.6	34.2	35.1	35.6	35.7	35.7	35.6	35.2	33.6	32.5	20.8
	Sk:	-23.0	-12.2	-8.1	-4.2	-1.2	1.6	4.3	7.1	14.1	17.3	33.1
Forstfeld eL 16.1; B + 47.1	Az:	146.4	163.6	170.0	175.7	180.1	184.2	188.2	192.3	202.7	207.7	234.8
	El:	30.3	34.6	35.4	35.8	35.9	35.8	35.6	35.2	33.4	32.1	20.1
	Sk:	-22.1	-11.0	-6.8	-2.9	0.1	2.9	5.6	8.4	15.3	18.5	33.8
Gmunden eL 13.8; B + 47.9	Az:	144.2	160.9	167.0	172.7	177.0	181.1	185.1	189.1	199.6	204.6	232.3
	El:	28.6	33.2	34.2	34.7	34.9	35.0	34.9	34.6	33.1	32.0	20.8
	Sk:	-23.1	-12.7	-8.7	-4.9	-2.0	0.7	3.4	6.1	13.0	16.2	32.0
Graz eL 15.4; B + 47.1	Az:	145.6	162.7	169.0	174.8	179.1	183.2	187.3	191.4	201.9	206.9	234.1
	El:	30.0	34.4	35.3	35.8	35.9	35.8	35.6	35.3	33.6	32.3	20.4
	Sk:	-22.6	-11.6	-7.5	-3.5	-0.6	2.2	5.0	7.7	14.7	18.0	33.5
Güssing eL 16.3; B + 47.1	Az:	146.7	164.0	170.2	176.1	180.5	184.5	188.6	192.7	203.1	208.1	235.1
	El:	30.4	34.7	35.4	35.9	35.9	35.8	35.6	35.2	33.3	32.0	19.9
	Sk:	-22.0	-10.9	-6.6	-2.7	0.3	3.1	5.8	8.5	15.5	18.7	33.9
Innsbruck eL 11.4; B + 47.3	Az:	141.2	157.7	163.7	169.5	173.8	177.9	181.9	186.0	196.7	201.9	230.2
	El:	28.1	33.2	34.4	35.1	35.5	35.6	35.7	35.5	34.3	33.3	22.6
	Sk:	-25.2	-14.9	-11.0	-7.1	-4.2	-1.5	1.3	4.1	11.2	14.6	31.4
Judenburg eL 14.6; B + 47.2	Az:	144.8	161.8	168.0	173.8	178.1	182.2	186.3	190.4	200.9	205.9	233.4
	El:	29.6	34.2	35.1	35.6	35.7	35.7	35.6	35.2	33.6	32.5	20.8
	Sk:	-23.1	-12.3	-8.2	-4.3	-1.3	1.5	4.3	7.0	14.0	17.3	33.0
Kapfenberg	Az:	145.7	162.7	168.9	174.7	179.0	183.1	187.2	191.2	201.7	206.7	233.9

el. 15.3; B + 47.4	El:	29.6	34.1	34.9	35.4	35.5	35.5	35.3	34.9	33.2	32.0	20.3
	Sk:	-22.5	-11.6	-7.5	-3.6	-0.6	2.1	4.9	7.6	14.5	17.7	33.2
Kirchschiegg el. 16.3; B + 47.5	Az:	146.9	164.1	170.3	176.1	180.4	184.5	188.5	192.5	202.9	207.9	234.6
	El:	30.0	34.2	35.0	35.4	35.4	35.1	34.7	32.9	31.6	19.6	
	Sk:	-21.7	-10.7	-6.6	-2.7	0.3	3.0	5.7	8.4	15.2	18.4	33.5
Kirzfeld el. 12.4; B + 47.5	Az:	142.4	159.0	165.1	170.8	175.1	179.2	183.3	187.3	197.9	203.0	231.1
	El:	28.4	33.3	34.4	35.1	35.4	35.5	35.4	35.2	33.9	32.9	21.9
	Sk:	-24.1	-14.0	-10.0	-6.2	-3.3	-0.6	2.2	4.9	12.0	15.3	31.7
Klägerfurt el. 14.2; B + 46.4	Az:	143.9	161.0	167.3	173.1	177.5	181.7	185.8	189.9	200.6	205.7	233.3
	El:	30.1	34.9	35.7	36.4	36.6	36.6	36.5	36.2	34.6	33.4	21.6
	Sk:	-23.9	-12.9	-8.7	-4.7	-1.7	1.1	4.0	6.8	14.0	17.3	33.5
Knittelfeld el. 14.9; B + 47.2	Az:	145.1	162.1	168.4	174.1	178.4	182.5	186.6	190.6	201.1	206.2	233.6
	El:	29.6	34.2	35.1	35.6	35.7	35.7	35.5	35.2	33.6	32.4	20.7
	Sk:	-22.9	-12.0	-7.9	-4.0	-1.0	1.8	4.5	7.3	14.2	17.5	33.2
Krems el. 15.6; B + 48.4	Az:	146.4	163.4	169.5	175.2	179.5	183.5	187.5	191.4	201.7	206.7	233.8
	El:	28.9	33.1	33.9	34.3	34.4	34.4	34.2	33.8	32.2	31.0	19.5
	Sk:	-21.5	-11.0	-7.0	-3.2	-0.4	2.3	5.0	7.6	14.2	17.4	32.4
Kirnuni el. 12.2; B + 47.1	Az:	142.0	158.6	164.7	170.5	174.8	178.9	183.0	187.1	197.8	202.9	231.1
	El:	28.6	33.6	34.7	35.4	35.7	35.9	35.8	35.6	34.3	33.3	22.2
	Sk:	-24.8	-14.4	-10.3	-6.5	-3.5	-0.7	2.0	4.8	12.0	15.4	32.0
Kufstein el. 12.2; B + 47.6	Az:	142.2	158.8	164.9	170.5	174.8	178.9	183.0	187.0	197.6	202.7	230.8
	El:	28.2	33.2	34.2	34.9	35.2	35.3	35.3	35.1	33.8	32.8	21.9
	Sk:	-24.4	-14.1	-10.1	-6.4	-3.5	-0.7	2.0	4.7	11.8	15.1	31.5
Köflach el. 15.1; B + 47.1	Az:	145.3	162.3	168.6	174.4	178.7	182.9	186.9	191.0	201.5	206.5	233.9
	El:	29.9	34.4	35.2	35.8	35.9	35.9	35.7	35.3	33.7	32.5	20.6
	Sk:	-22.6	-11.9	-7.7	-3.8	-0.8	2.0	4.7	7.5	14.5	17.7	33.4
Lanckow el. 10.6; B + 47.2	Az:	140.2	156.6	162.7	168.3	172.6	176.7	180.8	184.9	195.6	200.8	229.4
	El:	27.8	33.1	34.3	35.2	35.6	35.8	35.8	35.7	34.6	33.7	23.1
	Sk:	-25.8	-15.6	-11.7	-7.9	-5.0	-2.2	0.6	3.3	10.6	14.0	30.8
Laibitz el. 15.6; B + 46.8	Az:	145.7	162.9	169.2	175.0	179.4	183.5	187.6	191.7	202.2	207.2	234.5
	El:	30.3	34.8	35.6	36.1	36.2	36.2	35.9	35.6	33.8	32.6	20.5
	Sk:	-22.7	-11.6	-7.4	-3.4	-0.4	2.4	5.2	8.0	15.0	18.3	33.9
Lienz el. 12.8; B + 46.8	Az:	142.5	159.3	165.5	171.2	175.6	179.7	183.8	187.9	198.6	203.7	231.7
	El:	29.1	34.1	35.2	35.8	36.1	36.2	36.1	35.9	34.5	33.4	22.1
	Sk:	-24.6	-14.0	-9.9	-6.0	-3.0	-0.2	2.8	5.4	12.6	16.0	32.5
Liezén el. 14.3; B + 47.6	Az:	144.5	161.4	167.6	173.3	177.6	181.7	185.7	189.8	200.3	205.3	232.9
	El:	29.1	33.7	34.6	35.1	35.3	35.3	35.2	34.6	33.4	32.2	20.8
	Sk:	-23.0	-12.4	-8.3	-4.5	-1.6	1.2	3.9	6.6	13.6	16.8	32.5
Litz el. 14.3; B + 48.3	Az:	144.9	161.7	167.8	173.5	177.7	181.7	185.7	189.7	200.1	205.1	232.6
	El:	28.4	32.9	33.8	34.3	34.5	34.4	34.1	32.6	31.5	20.3	
	Sk:	-22.5	-12.1	-8.1	-4.4	-1.5	1.2	3.8	6.5	13.2	16.4	31.9
Loasen el. 15.1; B + 47.4	Az:	145.4	162.4	168.7	174.4	178.8	182.9	186.9	190.9	201.4	206.4	233.7
	El:	29.6	34.1	34.9	35.4	35.6	35.5	35.4	35.0	33.4	32.2	20.4
	Sk:	-22.6	-11.8	-7.7	-3.8	-0.8	1.9	4.7	7.4	14.3	17.5	33.1
Lötler el. 12.7; B + 47.6	Az:	142.7	159.4	165.5	171.2	175.5	179.6	183.6	187.7	198.3	203.4	231.3
	El:	28.4	33.3	34.3	35.0	35.2	35.3	35.3	35.1	33.7	32.7	21.7
	Sk:	-24.1	-13.7	-9.7	-5.9	-3.0	-0.3	2.5	5.2	12.2	15.5	31.8
Mariarel el. 15.3; B + 47.8	Az:	145.8	162.8	169.0	174.8	179.1	183.1	187.2	191.2	201.6	206.6	233.8
	El:	29.3	33.7	34.5	35.0	35.1	35.1	34.9	34.5	32.9	31.7	20.0
	Sk:	-22.2	-11.4	-7.4	-3.5	-0.6	2.1	4.8	7.5	14.3	17.5	32.8
Matteisburg el. 16.4; B + 47.7	Az:	147.1	164.2	170.4	176.2	180.5	184.8	188.6	192.6	203.0	207.9	234.8
	El:	29.8	34.0	34.8	35.1	35.2	35.1	34.8	34.4	32.6	31.4	19.4
	Sk:	-21.5	-10.5	-6.4	-2.6	0.4	3.1	5.8	8.5	15.2	18.4	33.4
Märzschlag el. 15.7; B + 47.6	Az:	148.2	163.3	169.5	175.2	179.6	183.9	187.7	191.7	202.1	207.1	234.2
	El:	29.6	34.0	34.8	35.2	35.3	35.3	35.0	34.7	33.0	31.7	19.9
	Sk:	-22.0	-11.2	-7.1	-3.2	-0.3	2.5	5.2	7.9	14.7	17.9	33.2
Pied el. 13.5; B + 48.2	Az:	143.9	160.6	166.7	172.4	176.6	180.7	184.7	188.7	199.1	204.2	231.6
	El:	28.2	32.8	33.8	34.4	34.6	34.6	34.5	34.3	32.9	31.8	20.8
	Sk:	-23.1	-12.8	-8.8	-5.1	-2.2	0.5	3.1	5.8	12.6	15.8	31.6
Poltenmann el. 14.4; B + 47.5	Az:	144.6	161.5	167.7	173.5	177.8	181.9	185.9	189.9	200.4	205.5	233.0
	El:	29.2	33.8	34.7	35.2	35.4	35.4	35.2	34.9	33.4	32.2	20.8
	Sk:	-23.0	-12.3	-8.3	-4.4	-1.5	1.3	4.0	6.7	13.7	16.9	32.7
Saitfelden el. 12.9; B + 47.4	Az:	142.9	159.6	165.7	171.4	175.7	179.9	183.9	187.9	198.5	203.6	231.6
	El:	28.6	33.5	34.6	35.2	35.4	35.5	35.5	35.2	33.9	32.8	21.7
	Sk:	-24.1	-13.6	-9.6	-5.8	-2.9	-0.1	2.7	5.4	12.5	15.8	32.0
Saizburg el. 13.1; B + 47.8	Az:	143.3	159.9	166.1	171.7	176.0	180.1	184.1	188.1	198.7	203.7	231.6
	El:	28.4	33.2	34.2	34.8	35.0	35.1	35.0	34.8	33.4	32.4	21.3
	Sk:	-23.7	-13.3	-9.3	-5.5	-2.6	0.1	2.8	5.5	12.5	15.7	31.8
Sant'Alcanta el. 15.6; B + 48.2	Az:	146.4	163.3	169.5	175.2	179.5	183.5	187.5	191.5	201.8	206.8	233.9
	El:	29.1	33.3	34.1	34.5	34.6	34.6	34.4	34.0	32.4	31.2	19.6
	Sk:	-21.7	-11.0	-7.0	-3.2	-0.4	2.3	5.0	7.6	14.3	17.5	32.6
Scheibbs	Az:	145.7	162.7	168.9	174.6	178.9	182.9	186.9	190.9	201.3	206.3	233.5

eL 15.2; B + 48.0	EI:	29.1	33.4	34.3	34.7	34.9	34.8	34.6	34.3	32.7	31.5	20.0
	SK:	-22.1	-11.5	-7.4	-3.6	-0.7	2.0	4.7	7.3	14.1	17.3	32.8
Schelling eL 14.3; B + 47.1	Az:	144.4	161.3	167.5	173.3	177.7	181.8	185.9	189.9	200.5	205.6	233.1
	EI:	29.5	34.2	35.1	35.7	35.8	35.9	35.7	35.4	33.8	32.7	21.1
Sk:	-23.4	-12.6	-8.5	-4.5	-1.6	1.2	4.0	6.7	13.8	17.1	33.0	
	Spritz eL 13.5; B + 46.8	Az:	143.3	160.2	166.4	172.2	176.6	180.7	184.8	188.9	199.6	204.7
EI:		29.4	34.3	35.3	35.9	36.1	36.2	36.1	35.8	34.3	33.2	21.7
St. Veit (a. d.) eL 14.4; B + 46.9	SK:	-24.1	-13.4	-9.3	-5.3	-2.4	0.5	3.3	6.1	13.2	16.6	32.9
	Az:	144.4	161.4	167.6	173.4	177.8	181.9	186.0	190.0	200.6	205.7	233.3
St. Veit eL 14.4; B + 46.9	EI:	29.7	34.4	35.3	35.9	36.1	36.1	35.9	35.6	34.0	32.8	21.1
	SK:	-23.4	-12.6	-8.4	-4.5	-1.5	1.3	4.1	6.9	14.0	17.3	33.2
St. Veit eL 14.4; B + 46.9	Az:	144.9	161.8	167.9	173.6	177.9	181.9	185.9	189.9	200.3	205.4	232.8
	EI:	29.7	33.2	34.1	34.6	34.6	34.8	34.8	34.3	32.6	31.7	20.4
St. Veit eL 14.4; B + 46.9	SK:	-22.6	-12.1	-8.1	-4.3	-1.4	1.3	3.9	6.6	13.4	16.6	32.1
	Stöckerau eL 16.3; B + 48.3	Az:	147.2	164.2	170.4	176.1	180.4	184.4	188.4	192.4	202.6	207.6
EI:		29.3	33.4	34.1	34.5	34.6	34.5	34.2	33.8	32.1	30.9	19.2
Stöckerau eL 16.3; B + 48.3	SK:	-21.1	-10.4	-6.4	-2.6	0.3	2.9	5.6	8.2	14.6	17.9	32.8
	Teugg eL 12.7; B + 47.3	Az:	142.6	159.3	165.5	171.1	175.5	179.5	183.6	187.7	198.3	203.4
EI:		28.7	33.6	34.6	35.3	35.6	35.7	35.6	35.4	34.1	33.0	21.9
Teugg eL 12.7; B + 47.3	SK:	-24.3	-13.9	-9.8	-6.0	-3.0	-0.3	2.5	5.2	12.3	15.7	32.0
	Willacht eL 13.9; B + 46.6	Az:	143.6	160.6	166.9	172.7	177.0	181.2	185.3	189.4	200.0	205.2
EI:		29.7	34.6	35.6	36.1	36.4	36.4	36.3	36.0	34.4	33.3	21.6
Willacht eL 13.9; B + 46.6	SK:	-24.0	-13.2	-9.0	-5.0	-2.0	0.9	3.7	6.5	13.7	17.0	33.3
	Wolfsberg eL 15.2; B + 47.1	Az:	145.3	162.4	168.7	174.5	178.8	182.9	187.0	191.1	201.6	206.6
EI:		29.9	34.4	35.3	35.8	35.9	35.9	35.7	35.3	33.7	32.4	20.6
Wolfsberg eL 15.2; B + 47.1	SK:	-22.7	-11.8	-7.6	-3.7	-0.7	2.0	4.8	7.6	14.5	17.8	33.4
	Wolfsberg eL 15.3; B + 48.8	Az:	146.2	163.1	169.2	174.8	179.0	183.3	187.0	190.9	201.2	206.2
EI:		29.4	32.6	33.4	33.9	34.0	33.9	33.8	33.4	31.8	30.7	19.4
Wolfsberg eL 15.3; B + 48.8	SK:	-21.5	-11.1	-7.1	-3.4	-0.6	2.0	4.6	7.2	13.8	16.9	31.9
	Weiz eL 15.4; B + 47.1	Az:	145.6	162.8	169.0	174.8	179.2	183.3	187.4	191.4	201.9	206.9
EI:		30.0	34.4	35.3	35.7	35.9	35.8	35.6	35.2	33.5	32.3	20.4
Weiz eL 15.4; B + 47.1	SK:	-22.6	-11.6	-7.5	-3.5	-0.6	2.2	5.0	7.7	14.7	18.0	33.5
	Weiz eL 14.0; B + 48.2	Az:	144.5	161.3	167.4	173.1	177.3	181.4	185.4	189.4	199.8	204.8
EI:		28.5	33.0	33.9	34.5	34.7	34.7	34.6	34.3	32.8	31.7	20.5
Weiz eL 14.0; B + 48.2	SK:	-22.8	-12.4	-8.4	-4.6	-1.8	0.9	3.6	6.2	13.0	16.2	31.8
	Weiz eL 16.4; B + 48.2	Az:	147.2	164.3	170.5	176.2	180.5	184.5	188.5	192.5	202.8	207.7
EI:		29.4	33.5	34.2	34.6	34.6	34.6	34.3	33.9	32.1	30.9	19.2
Weiz eL 16.4; B + 48.2	SK:	-21.1	-10.4	-6.3	-2.5	0.4	3.0	5.7	8.3	15.0	18.1	32.9
	Wolfsberg eL 14.9; B + 46.8	Az:	144.9	162.0	168.3	174.1	178.4	182.5	186.7	190.7	201.3	206.4
EI:		30.0	34.6	35.5	36.0	36.2	36.1	36.0	35.6	34.0	32.8	20.9
Wolfsberg eL 14.9; B + 46.8	SK:	-23.2	-12.2	-8.0	-4.0	-1.0	1.8	4.6	7.4	14.4	17.7	33.5
	Wörgl eL 12.1; B + 47.5	Az:	142.0	158.6	164.7	170.3	174.6	178.7	182.8	186.8	197.5	202.6
EI:		28.2	33.2	34.3	35.0	35.3	35.4	35.4	35.2	34.0	33.0	22.1
Wörgl eL 12.1; B + 47.5	SK:	-24.6	-14.3	-10.3	-6.5	-3.6	-0.8	1.9	4.7	11.7	15.1	31.6

*Note: If you are missing the city you are living in, please visit <http://www.lyngsat.com/>