

onex

DIGITAL



REF: 751944

ES VISUALTECH 5H

EN VISUALTECH 5W

auta

Bringing people together

Descripción Description

Monitor digital VISUALTECH 5H con tecnología Wi-Fi. Puede ser instalado, mediante 5 cables, en cualquier sistema Auta Visualtech. Incorpora una pantalla panorámica LCD COLOR 7", tecnología táctil, audio manos libres, captura de imágenes durante la llamada, salidas auxiliares multi-función, selección de melodías, funciones especiales. Permite su gestión remota a través de uno o varios dispositivos móviles y nuestra APP **Auta ONEX Wi-Fi**, tanto dentro de la vivienda como en el exterior vía 3G, 4G o 5G.

VISUALTECH 5H digital monitor with Wi-Fi technology. It can be installed, using 5 cables, in any Auta Visualtech system. It incorporates a 7" COLOR LCD panoramic screen, touch technology, hands-free audio, capture images during the call, multi-function auxiliary outputs, melody selection, special functions. It allows remote management through one or several mobile devices and our **Auta ONEX Wi-Fi APP**, both inside the home and outside by 3G, 4G or 5G.

Características Features

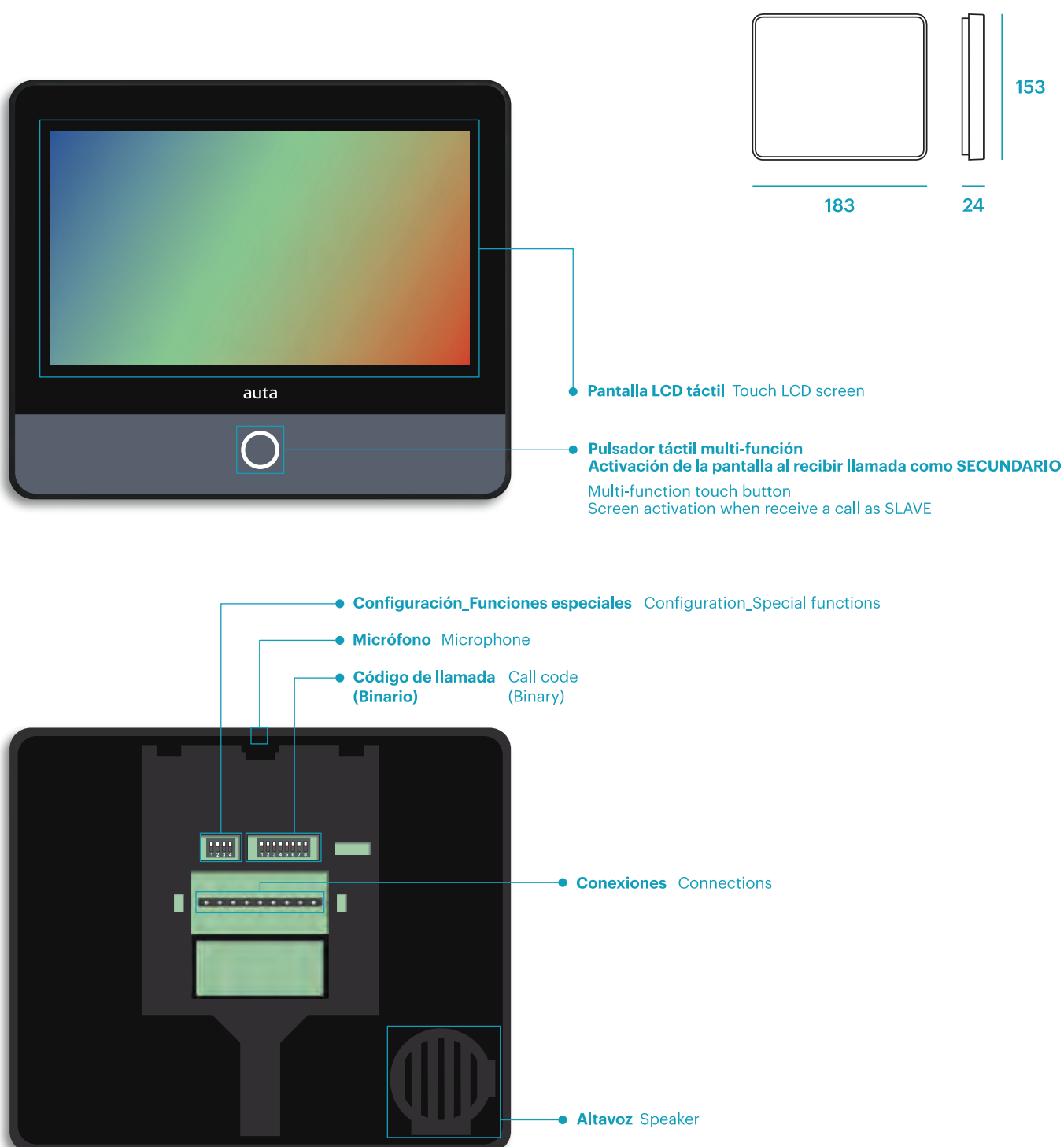

Montaje Mounting

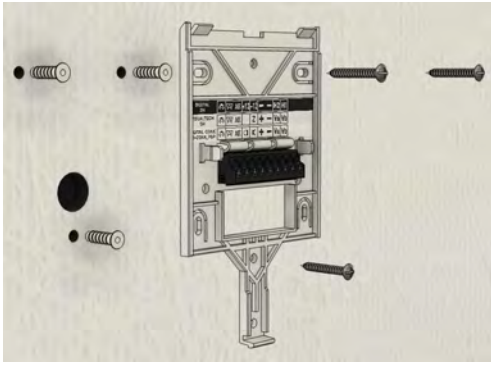

Soporte NO INCLUIDO
Bracket NOT INCLUDED

1



2

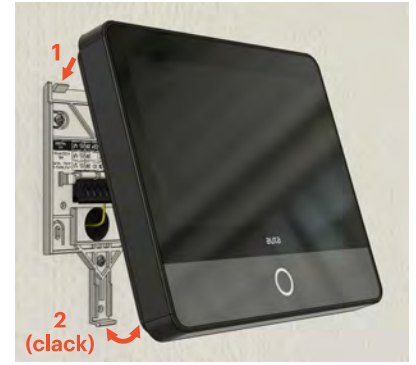

3

Instalación Installation

Monitor como principal Monitor as main

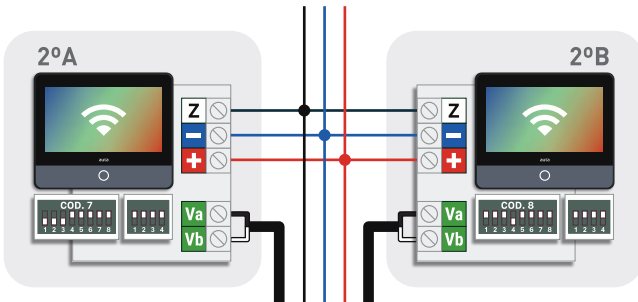

Monitor como principal + secundario Monitor as main + secondary

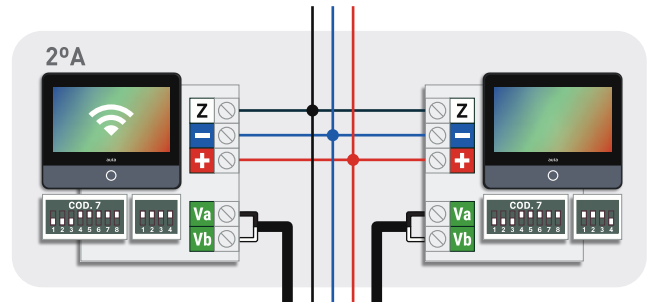

Manual de instalación VIDEO VISUALTECH 5H
Installation manual VIDEO VISUALTECH 5W

Configuración Configuration

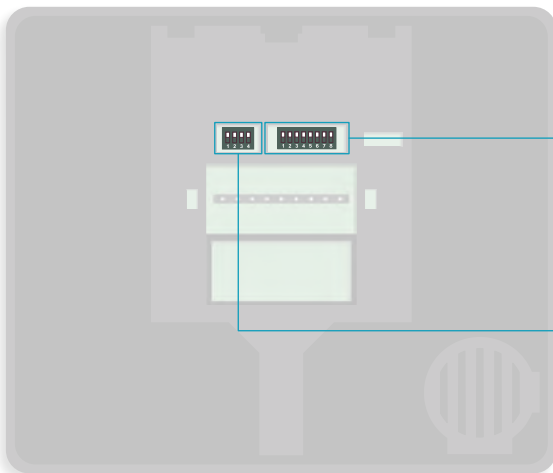

Configuración del sistema digital
Digital system configuration



Principal
Main



Secundario
Secondary



Carga video ON
Video load ON



Carga video OFF
Video load OFF

Funcionamiento Functioning

activación del monitor activation of the monitor

EN REPOSO, para prevenir pulsaciones indeseadas, el monitor incorpora un sistema de seguridad en el que la pantalla táctil permanece bloqueada hasta que se presiona el pulsador . Si se presiona durante 10 segundos el monitor se re-iniciará.

IN STANDBY, to prevent unwanted keystrokes, the monitor incorporates a security system in which the touch screen remains locked until the button  is pressed. If it is pressed for 10 seconds the monitor will restart.

menú de usuario user menu

Al presionar el pulsador de activación  el monitor nos ofrece 4 opciones.

By pressing the activation button  the monitor offers us 4 options.



15:01 Hora sincronizada de forma automática por nuestros servidores.
Time automatically synchronized by our servers.



Indicador multi-estado de conexión Wi-Fi.

Multi-state indicator for Wi-Fi connection.



Módulo Wi-Fi conectado. Wi-Fi module connected.



Módulo Wi-Fi desconectado. Wi-Fi module disconnected.



Llamada a terminal móvil activa. Call to mobile terminal active.



Indicador de estado para los tonos de llamada.

State indicator for the calling tones.



Modo estándar, tonos de llamada activos.
Standard mode, calling tones active.



Modo "No molestar". Mode "Not disturb".



Actualización disponible. Available update.



Llamadas perdidas. Miss calls.

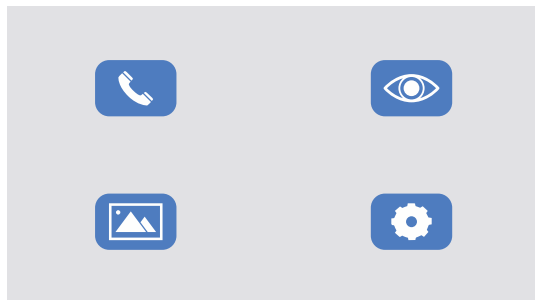

Al presionar accedemos al menú de llamadas.

By pressing we access to the calls menu.



Llamada a conserjería
Call to concierge



Llamada monitor a móvil
Call monitor to mobile
(Próximamente. Coming soon)



Llamada monitor a monitor
Call monitor to monitor
(Próximamente. Coming soon)



Auxiliar
Auxiliary



Presionando accedemos a la placa o cámara en la que estemos vinculados.

By pressing we access to the Panel_Camera in which we are linked.



Presionando accedemos a la galería de imágenes almacenadas. Podemos elegir la Placa_Cámara cuyas imágenes queremos visualizar.

By pressing we access to the gallery of stored images. We can choose the Panel_Camera whose images we want to visualize.



Presionando accedemos al menú de configuración del monitor.

By pressing we access to the monitor configuration menu.



Ajuste de volumen y melodías
Melody and Volume settings



Gestión de Wi-Fi
Wi-Fi management



Vinculación del monitor
Monitor pairing.
APP Auta ONEX Wi-Fi



Información de sistema.
Descarga de aplicaciones.
System info. Download APP's



Ajustes avanzados
Contraseña: 1234
Advanced settings
Password: 1234



Ajuste de franja horaria
Defecto: España
Time zone setting
Default: Spain



Actualizar monitor
Monitor update



Guía rápida APP
APP quick guide



opciones durante la llamada

Cuando se recibe una llamada desde una Placa_Conserje, las siguientes opciones estarán disponibles.



 Al presionar podemos accionar la apertura del dispositivo que estemos viendo en pantalla.

 Al presionar abriremos el canal de comunicación.

 Al presionar finalizaremos la conversación en curso y el monitor pasará a reposo.

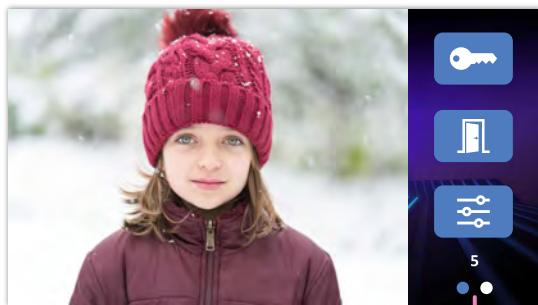

 Al presionar podemos accionar la apertura del dispositivo que estemos viendo en pantalla.

 Al presionar accionaremos la salida auxiliar del monitor.

 Al presionar accederemos al menú de ajuste de imagen, brillo, color y contraste. Para salir del menú deberemos presionar el botón de guardar.

Pulsar para cambiar de menú

opciones durante la conversación

Cuando se establece una conversación con una Placa_Conserje_Cámara, las siguientes opciones estarán disponibles.

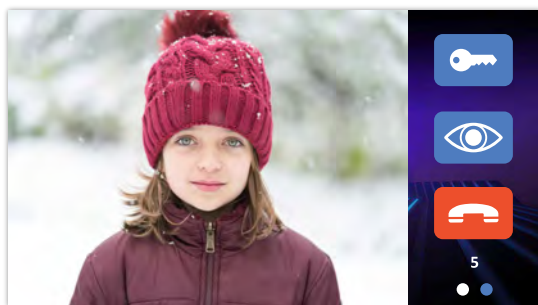

 Al presionar podemos accionar la apertura del dispositivo que estemos viendo en pantalla.

 Al presionar podemos visualizar y recorrer las placas o cámaras en la que estemos enlazados.

 Al presionar finalizaremos la conversación en curso y el monitor pasará a reposo.

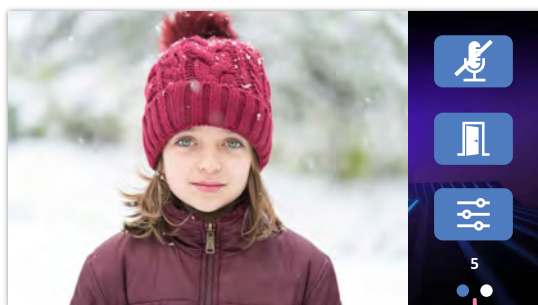

 Al presionar podemos silenciar el audio que emite el monitor. Ofreciendo así privacidad siempre que se desee.

 Al presionar accionaremos la salida auxiliar del monitor.

 Al presionar accederemos al menú de ajuste de imagen, brillo, color y contraste. Para salir del menú deberemos presionar el botón de guardar.

Pulsar para cambiar de menú

options during the call

When a call is received from a Concierge_Panel, the following options will be available.



By pressing we can activate the opening of the device that we are seeing on the screen.



By pressing we will open the communication channel.



Pressing will end the conversation in progress and the monitor will go to standby.



By pressing we can activate the opening of the device that we are seeing on the screen.



When pressing we will activate the auxiliary output of the monitor.



By pressing we will access the image, brightness, color and contrast adjustment menu. To exit the menu we must press the save button.

Press to change the menu

options during the conversation

When establishing a conversation with a Panel_Concierge_Camera, the following options will be available.

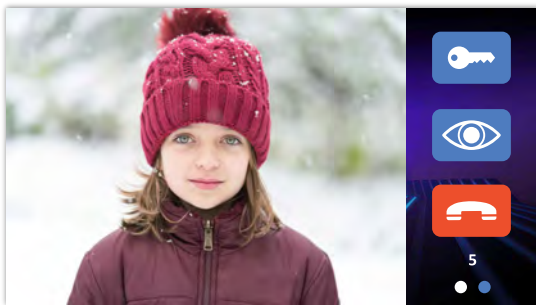

By pressing we can activate the opening of the device that we are seeing on the screen.



By pressing we can visualize and go through the panel or cameras in which we are linked.



Pressing will end the conversation in progress and the monitor will go to standby.

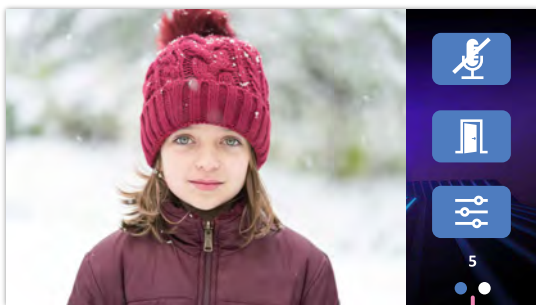

By pressing we can mute the audio emitted by the monitor. Thus offering privacy whenever desired.



When pressing we will activate the auxiliary output of the monitor.



By pressing we will access the image, brightness, color and contrast adjustment menu. To exit the menu we must press the save button.

Press to change the menu