

auta

ANALOG



REF. 730180

ES CONMUTADOR DE AUDIO CA-2 MINI

EN CA-2 MINI AUDIO SWITCHER

auta

Bringing people together

Descripción Description

Conmutador de audio que permite la conexión de 2 puertas de acceso con placas analógicas Auta en sistemas 4 + N.

El conmutador dispone de 2 modos de funcionamiento:

- **MODO 1** : Modo predefinido de fábrica. Cuando se realiza una llamada desde un acceso el conmutador establece comunicación con dicha placa durante 90 segundos como máximo. Si durante la conversación se realiza la llamada desde el segundo acceso el conmutador cortará la comunicación con el primero y conectará con este segundo acceso.
- **MODO 2** : Cuando se realiza una llamada desde un acceso el conmutador establece comunicación con dicha placa durante 90 segundos como máximo. El conmutador permanecerá en dicho acceso hasta que finalice el tiempo aunque se realice una llamada desde el segundo. En el segundo acceso deberán esperar a que finalice el tiempo para poder realizar la llamada.

Audio switcher which allows to connect 2 access doors with Auta analog panels at 4 + N systems.

The switcher has 2 working modes:

- **MODE 1** : Mode predefined in factory. When a call is made from an access, the switcher establishes communication with said panel for a maximum of 90 seconds. If during the conversation a call is made from the second access, the switcher will cut off the communication with the first one and will connect with that second access.
- **MODE 2** : When a call is made from an access, the switcher establishes communication with said panel for a maximum of 90 seconds. The switcher will remain in said access until the time expires even if a call is made from the second one. In the second access customer must wait for the time to end to be able to make the call.

Dimensiones Dimensions

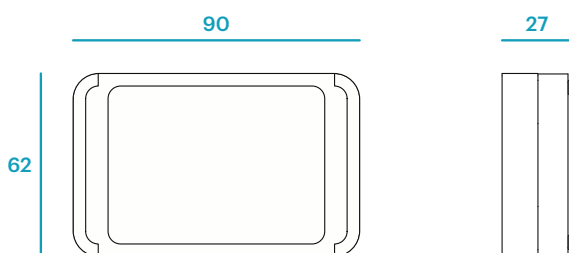

Características Features



DISPARO TRIGGER A	Ao	Generador de llamada (placa A)	Call generator (panel A)
	A	Hilo común de pulsadores (placa A)	Push-buttons common wire (panel A)
DISPARO TRIGGER B	Bo	Generador de llamada (placa B)	Call generator (panel B)
	B	Hilo común de pulsadores (placa B)	Push-buttons common wire (panel B)
	-	Selección del MODO 2 (conectar al - del sistema)	Selection of MODE 2 (connect to - of the system)
	Rs	NO USADO	NOT USED
VIVIENDAS FLATS	S1 S2 S3 S4	Conexión de los hilos comunes de la vertical (COMÚN, ALTAVOZ, MICRO y ABREPUERTAS)	Connection of the riser common wires (COMMON, SPEAKER, MICRO and DOOR)
PLACA A PANEL A	A1 A2 A3 A4	Conexión de los hilos comunes de la placa A (COMÚN, ALTAVOZ, MICRO y ABREPUERTAS)	Connection of the panel A common wires (COMMON, SPEAKER, MICRO and DOOR)
PLACA B PANEL B	B1 B2 B3 B4	Conexión de los hilos comunes de la placa B (COMÚN, ALTAVOZ, MICRO y ABREPUERTAS)	Connection of the panel B common wires (COMMON, SPEAKER, MICRO and DOOR)
		RECOMENDADA PARA EL ACCESO EXTERIOR	RECOMMENDER FOR THE EXTERNAL ACCESS
POWER	12V ~	12 Vca	12 Vac
	12V ~	12 Vca	12 Vac

Grupo de audio MF-S (509002) Audio speaker MF-S (509002)

TF. LLAMADA ELECTRÓNICA
PH. ELECTRONIC CALL

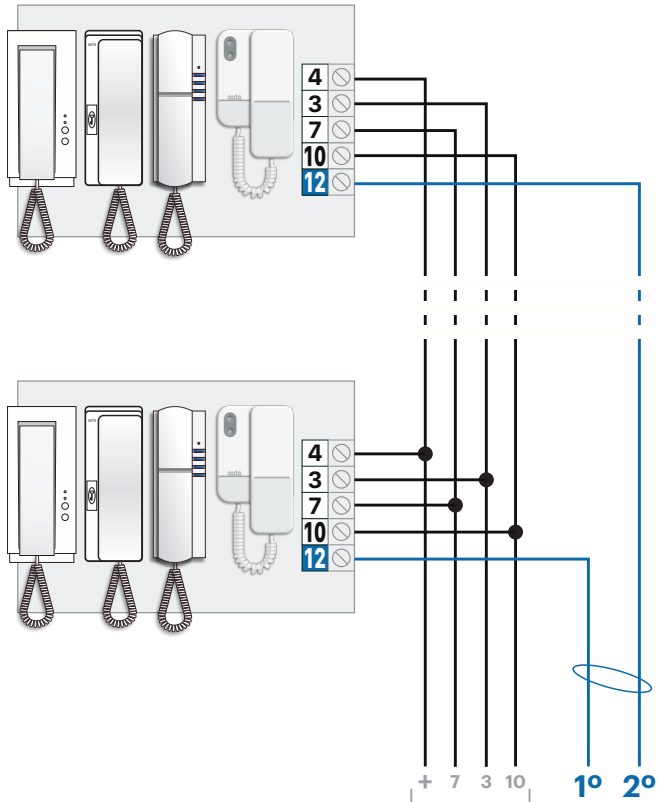

EL CABLE 12 DE CADA VIVIENDA SE CONECTARÁ AL TORNILLO INTERIOR DE SU PULSADOR DE LLAMADA EN AMBAS PLACAS.

THE 12 WIRE WILL BE CONNECTED TO THE INTERNAL SCREW OF ITS CALLING PUSH-BUTTON AT BOTH PANELS.

TF. LLAMADA ZUMBADOR
PH. BUZZER CALL

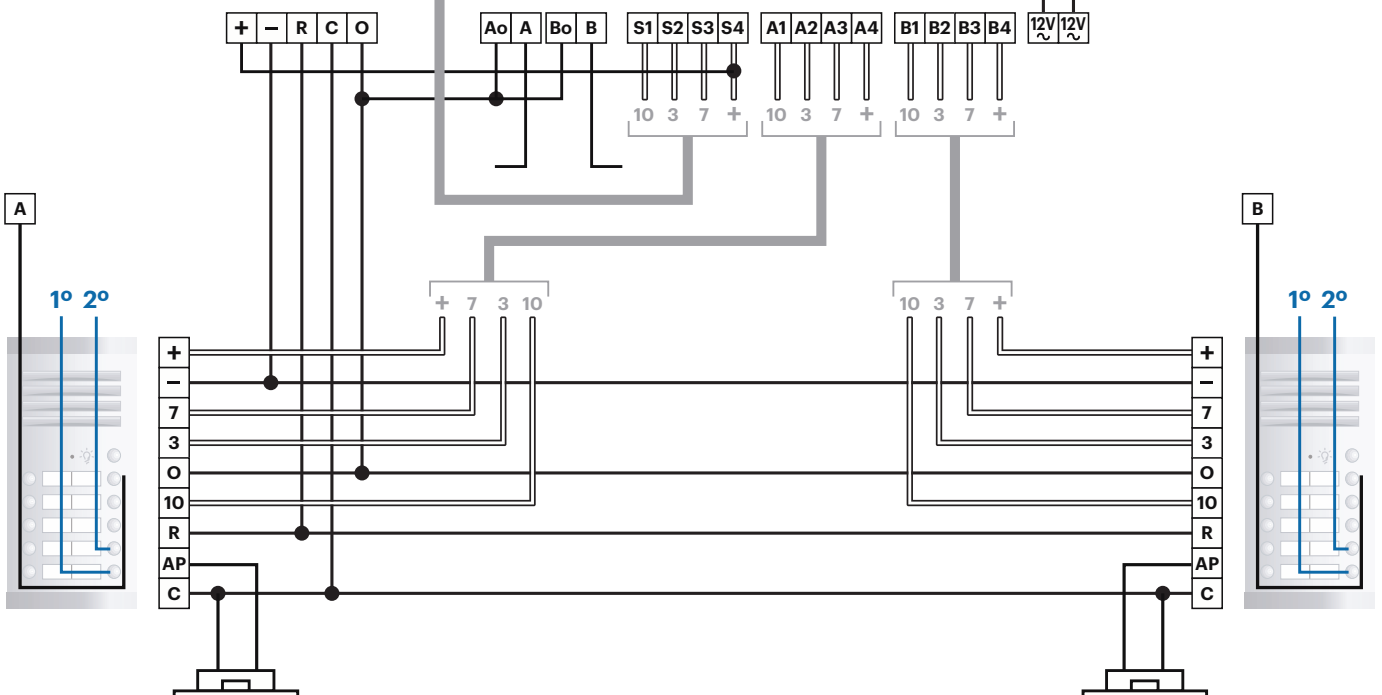
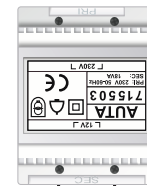
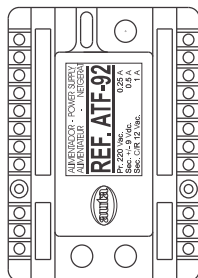
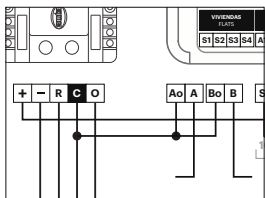

Grupo de audio MF-S2 (509014) Audio speaker MF-S2 (509014)

TF. LLAMADA ELECTRÓNICA
PH. ELECTRONIC CALL

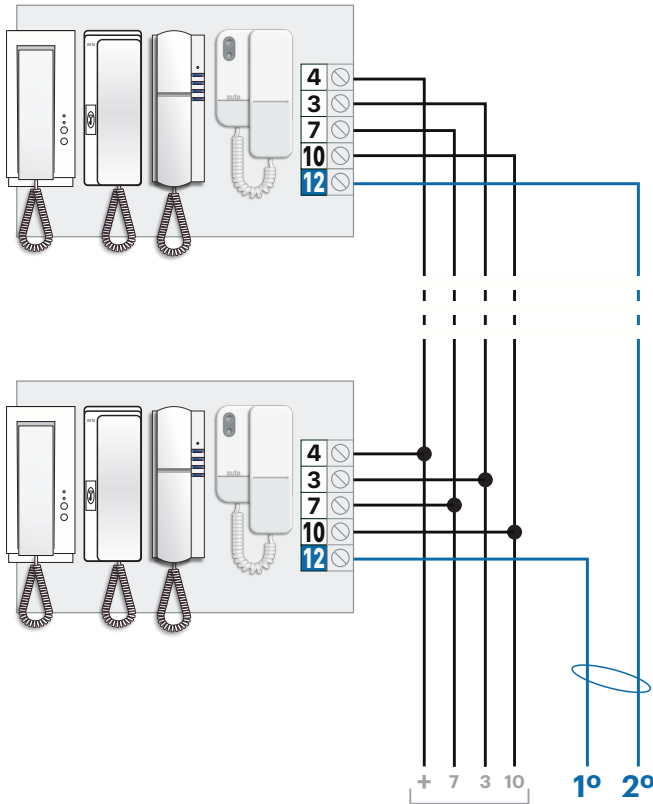

EL CABLE 12 DE CADA VIVIENDA SE CONECTARÁ AL TORNILLO INTERIOR DE SU PULSADOR DE LLAMADA EN AMBAS PLACAS.

THE 12 WIRE WILL BE CONNECTED TO THE INTERNAL SCREW OF ITS CALLING PUSH-BUTTON AT BOTH PANELS.

TF. LLAMADA ZUMBADOR
PH. BUZZER CALL

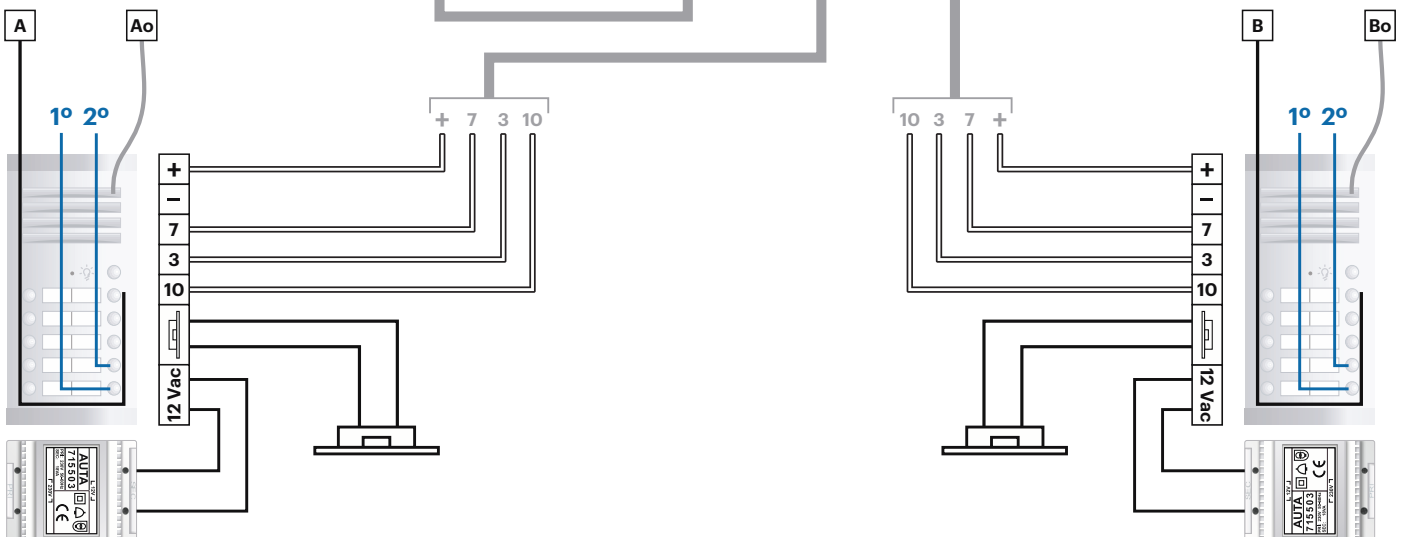
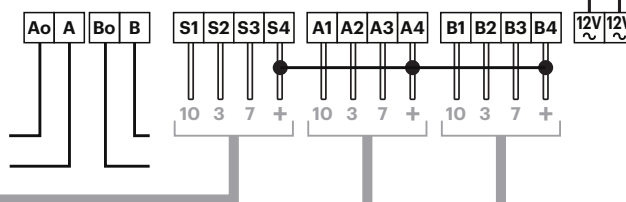
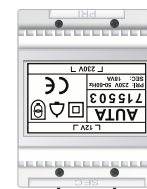
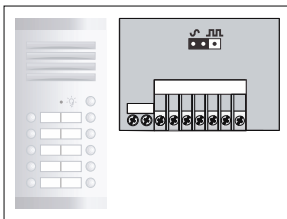

Grupo de audio COMPACT (509051) Audio speaker COMPACT (509051)

TF. LLAMADA ELECTRÓNICA
PH. ELECTRONIC CALL

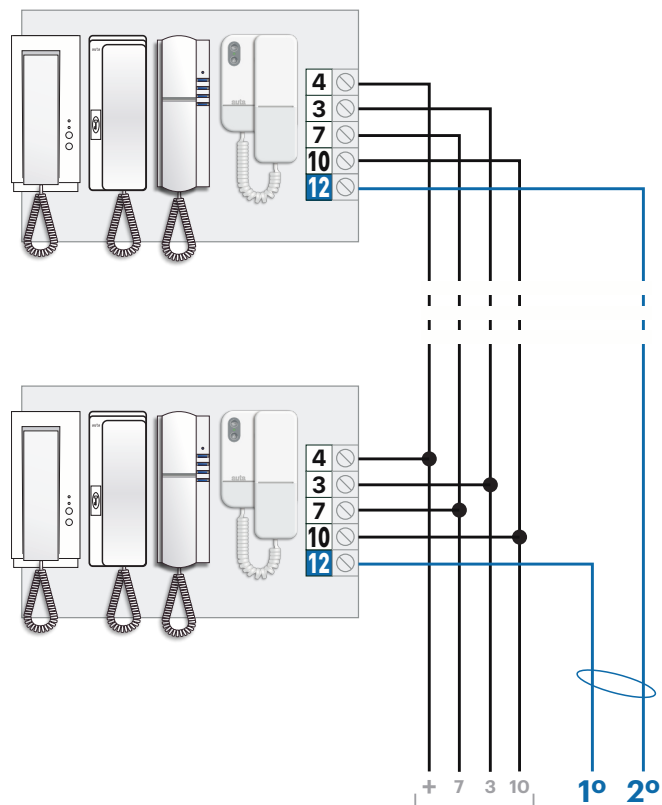

EL CABLE 12 DE CADA VIVIENDA SE CONECTARÁ AL TORNILLO INTERIOR DE SU PULSADOR DE LLAMADA EN AMBAS PLACAS.

THE 12 WIRE WILL BE CONNECTED TO THE INTERNAL SCREW OF ITS CALLING PUSH-BUTTON AT BOTH PANELS.

TF. LLAMADA ZUMBADOR
PH. BUZZER CALL

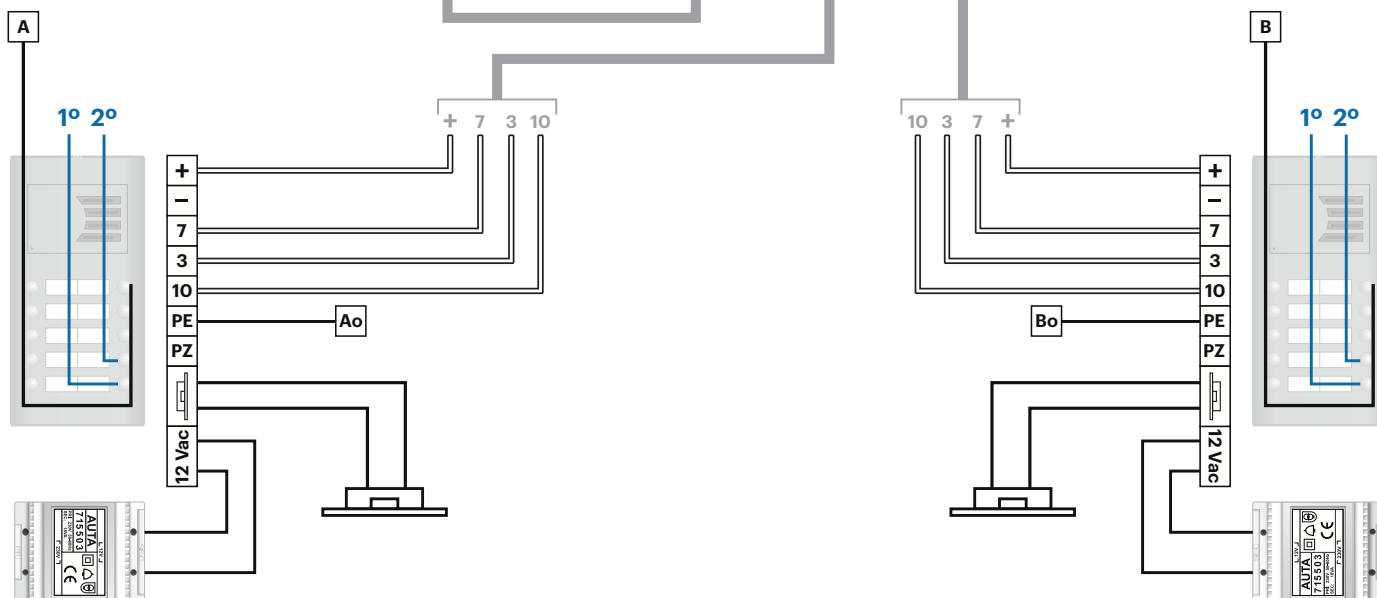
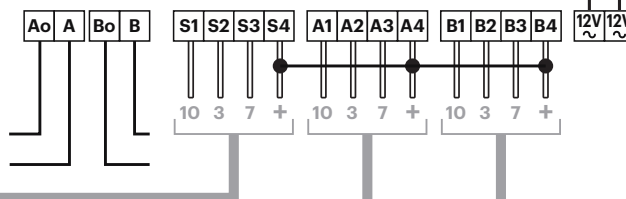
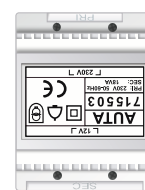
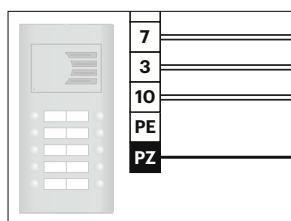

Grupo de audio MF-93 (509901) Audio speaker MF-93 (509901)

TF. LLAMADA ELECTRÓNICA
PH. ELECTRONIC CALL

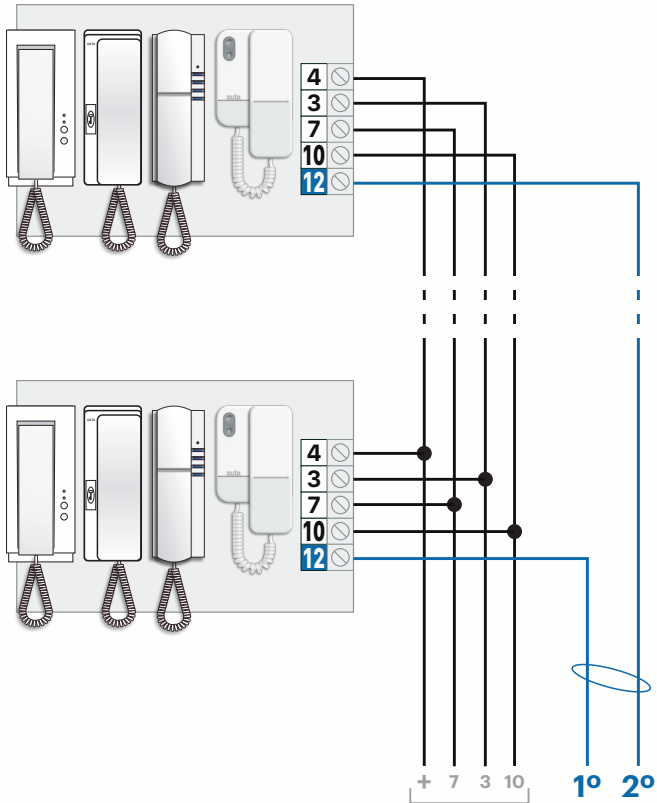

EL CABLE 12 DE CADA VIVIENDA SE CONECTARÁ AL TORNILLO INTERIOR DE SU PULSADOR DE LLAMADA EN AMBAS PLACAS.

THE 12 WIRE WILL BE CONNECTED TO THE INTERNAL SCREW OF ITS CALLING PUSH-BUTTON AT BOTH PANELS.

TF. LLAMADA ZUMBADOR PH. BUZZER CALL

