

Simrad
VHF Radiotelephone

Shipmate
RS8100

183.2021.005 Rev.E English

Warning! *The handset must be turned off while you connect/disconnect the plug for the handset.*

Contents

DISTRESS CALL	overleaf
Introduction.....	1
Status Displays.....	2
Handset Keys	3
ON/OFF Switch	4
International and US Channels	6
Channel Selection	7
Output Power.....	8
Squelch.....	8
Volume.....	9
Dual Watch	10
Scan All	12
Exclusions from Scan All.....	14
Scan Programme	16
Intercom.....	20
Muting.....	21
Illumination	21
Installation	22
Technical Data.....	26
Marine VHF Channels	28
International Warranty	30
SHIPMATE Agents	31

If you need to make a **DISTRESS CALL**

Select the Distress Channel

16

Hold down the PTT lever on handset.

Transmit calmly, but loud and clear:

MAYDAY - MAYDAY - MAYDAY

THIS IS: *State vessel's name Three Times*

MAYDAY THIS IS: *Repeat vessel's name*

AT POSITION: *State position of vessel*

STATE NATURE OF DISTRESS

Release PTT lever.

Wait briefly for an answer.

If not answered after a short interval, repeat message until answered.

Introduction

The RS8100 is designed for remote installation of the main unit. Two handsets may be fitted and each can be plugged in up to 20m (65ft) from the main unit. Programming and operation of the set is carried out solely through the handsets, either of which may be used for this purpose, in or out of its cradle.

While one handset is in use, the second one will display the legend OCC. However, handset No. 1 will always override handset No. 2.

The Press To Transmit lever, located on the reverse of the keypad, must only be pressed when transmitting. Care should be taken not to press it accidentally when programming a handset out of its cradle.

Information regarding channel selection, operating mode and output power is always given on the handset display. Volume and Squelch levels are displayed momentarily when settings are changed. Selection of an unauthorised channel is indicated by the legend ERROR.

The keypad has numerical keys for channel selection and function keys for controlling volume, squelch and scan modes. Key P allows access to private, authorised channels. In addition, key E controls the programming of secondary functions. The legend SHIFT will be shown in the handset display whenever this key is pressed. All key entries are acknowledged by a short tone.

Handset Status Displays

INT	International Channels set	SB	Programme in Stand-by
US	US Channels set	IW	Output reduced
P3	Private Channel operative	TX	Set is transmitting
16	Channel operative	ERROR	Incorrect selection
10	Channel pre-selected	SHIFT	Secondary functions available
SCAN ALL	Scan All operative	5	Squelch or volume setting
67 16 10	Channels selected for Scan Programme	OCC	Other handset in use
SCAN PRG	Scan Programme operative	INTERCOM	Intercom selected
DW	Dual Watch operative		

Handset Keys

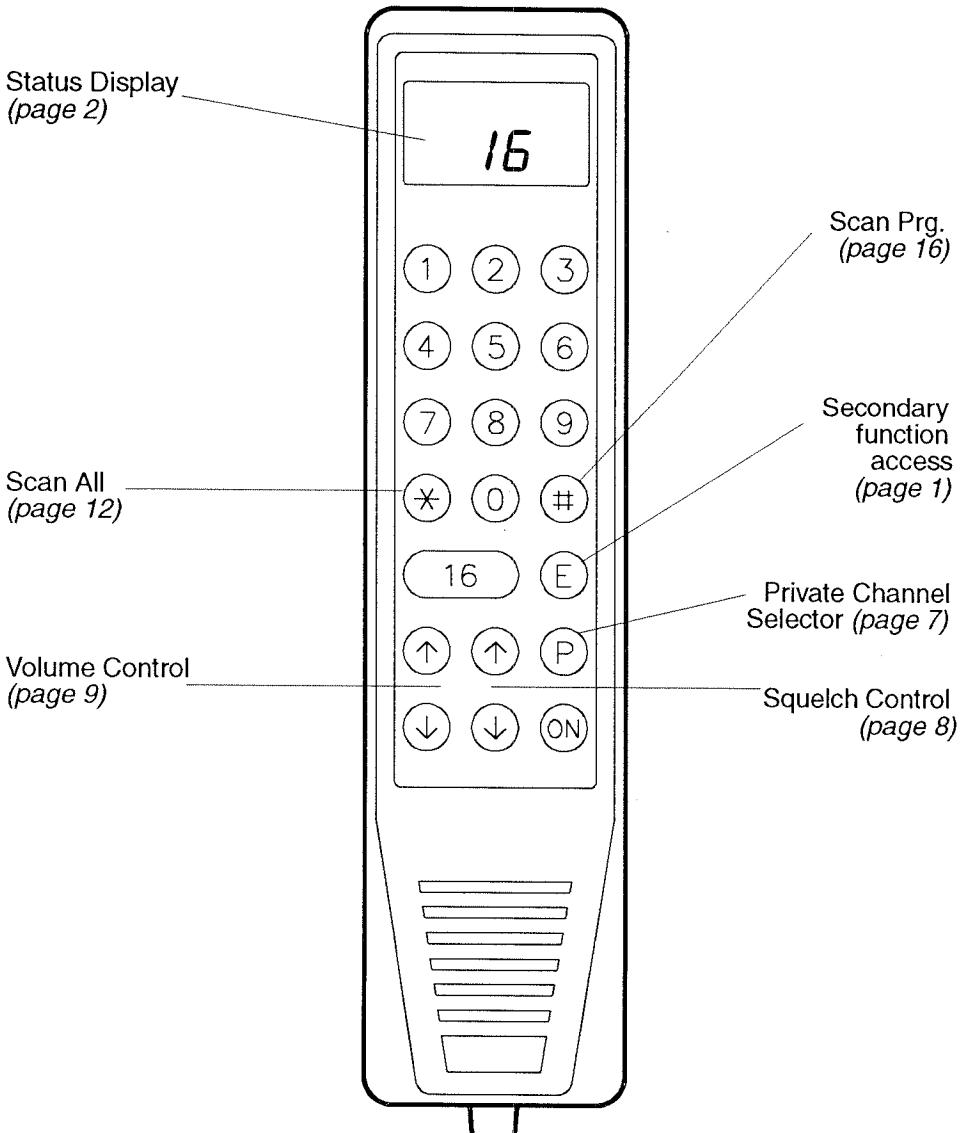

The ON/OFF Switch is fitted at the base of the main unit and a stand-by facility on the handset allows power consumption to be reduced to 20mW, so that the set can be left on almost indefinitely.

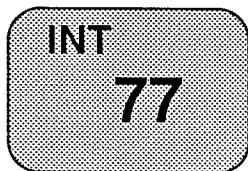

Set the ON/OFF switch of the main unit to the ON position. The display should immediately show the last channel used.

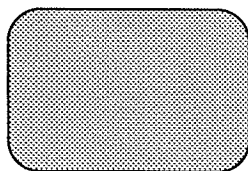

If the last channel is not displayed, it is an indication that the main unit was switched off while the handset was in the stand-by mode.

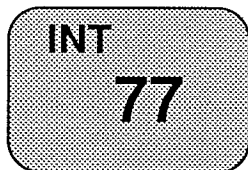

In that event, press the ON button of the handset once. The channel will be displayed and the unit will be fully operational.

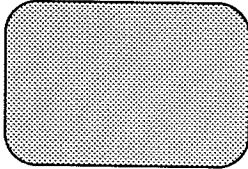

On closing down, press the ON button of the handset and then release it. The display will disappear and power consumption will be reduced to 20mW.

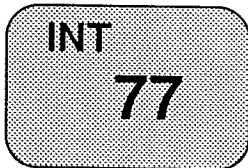

To revert to full operational status from the stand-by mode, simply press the handset ON button once.

If the vessel is to be left unattended for any length of time, the unit should be switched off by setting the ON/OFF switch at the base of the unit to the OFF position.

International and US channels may be used with this unit, permitting operation in all waters. The same handset programme keys effect the change from one system to the other.

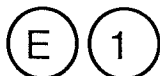
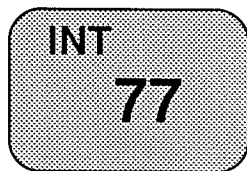

To change from US system to International channels.



To change from International to US channels. If the legend ERROR is displayed, it indicates that US channels are not available.

US Channels 13 & 67 are limited to 1W output. This is shown by a flashing 1W on the display. For 25W output, press the ON button and the PTT key. When using these channels the handset OFF will be inoperative.

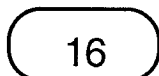
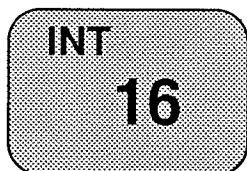

To select the International Distress Channel and General Calling Frequency.

Channel Selection allows access to all legally permissible channels. It also permits direct, single key, operation for the distress and general calling frequency.

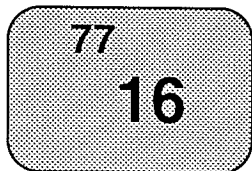

To select any public channel, for example, Ship to Ship Channel 77.

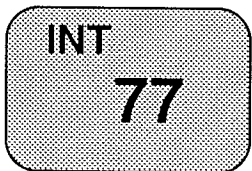

The display will change automatically after 3.5 seconds, or immediately after button **E** is pressed.

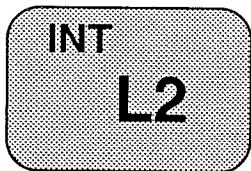

To select a private authorised channel, say Private Channel 3. This will be displayed 3.5 seconds after selection, or immediately after button **E** is pressed.

Output Power can be set to either 1W or to 25W.

Squelch is adjustable in eight steps from minimum to maximum.

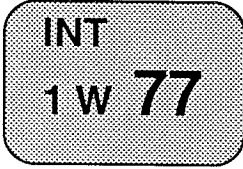

To reduce output power to 1W for short range transmissions.

Regardless of what power was set when the unit was switched off, when it is switched on again it will be at maximum output.

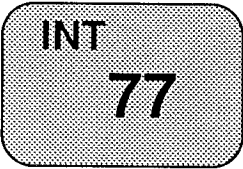

To change from reduced power output to full 25W output for maximum range.

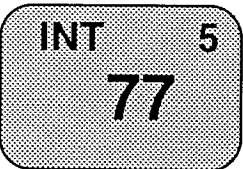

When the set is switched on, the squelch setting will be at 2. Adjust this in steps until noise is heard.

Volume is adjustable in eight steps from minimum to maximum.

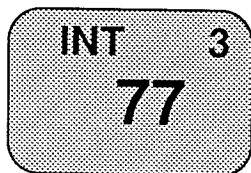

Carefully press the increase button until the noise only just disappears.

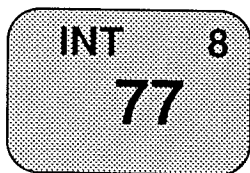

When the set is switched on, volume will automatically be at setting 3. This can be increased in steps up to setting 8.

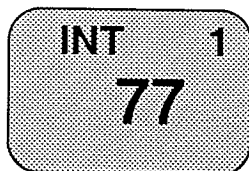

Volume can also be reduced in steps down to setting 1.

Dual Watch will automatically monitor Channel 16 as well as one other channel pre-selected by the operator. It will function only if there is no noise on squelch and both handsets are in their cradles.

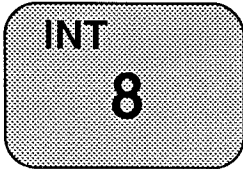

Set the pre-selected second channel, for example, Channel 8.

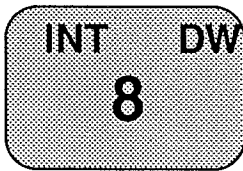

Activate Dual Watch.

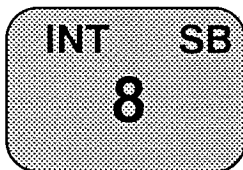

Monitoring of Channel 16 stops when a handset is lifted from its cradle. The pre-selected channel immediately becomes available for communication, and the receiver changes to Stand-by ready to resume Dual Watch.

When a transmission is detected on Channel 16, the Dual Watch will lock the receiver on to that frequency. It will be locked until the signals stop or a handset is lifted for use on the pre-selected channel.

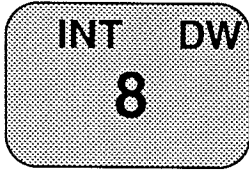

When the handset is returned to its cradle, full Dual Watch function is automatically resumed. Both Channel 16 and the pre-selected channel will again be monitored until a signal is detected or until a handset is lifted from its cradle.

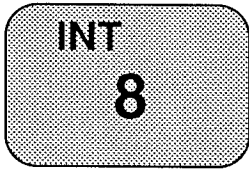

To terminate Dual Watch. Another channel may thereafter be selected for monitoring and Dual Watch be reactivated.

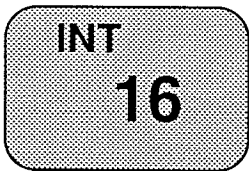

If, while on Dual Watch, the set is used to transmit on Channel 16, Dual Watch is effectively terminated. To resume Dual Watch, a channel in addition to Channel 16 must be pre-selected. Dual watch can then be reactivated.

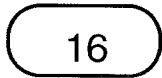

Scan All mode monitors all public channels for transmissions. Squelch must be set above level 1 before this mode can be selected.

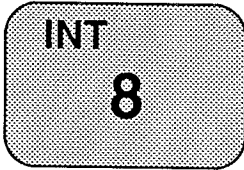

It is good practice before starting Scan All, to ensure that any previously excluded channels are restored.

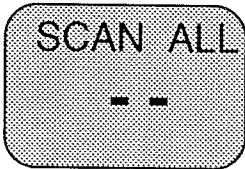

To start Scan All mode.

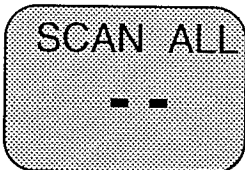

While scanning is in progress, channel numbers will not be displayed.

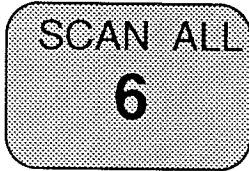

When a transmission is detected, the set will lock on for five seconds and display the number of the channel it is locked on to.

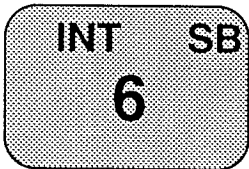

When the handset is lifted, the scanning stops. Enter the latest used channel, and the unit is ready for communication.

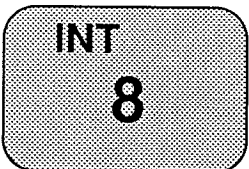

The Scan All mode can be terminated at any time.



Exclusions from Scan All can be made for up to two channels. This will prevent continuously transmitting stations, such as V.H.F. Direction Beacons, from intruding.

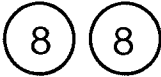
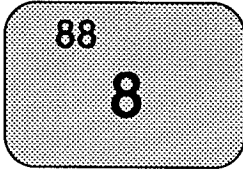

Set in the number of the channel to be excluded from Scan All programme.

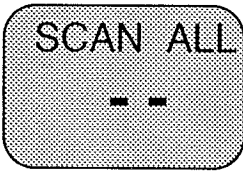

Press immediately, otherwise channel selected for exclusion will instead be programmed for transmission.

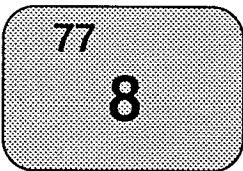

If required, set in number of a second channel to be excluded from Scan All programme.

Unless specifically reinstated, channels which are programmed for exclusion from Scan All will remain excluded even if the unit is switched off and then switched on again.

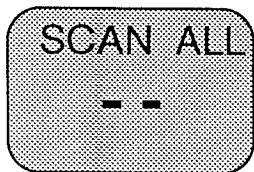

Press immediately to start scanning.

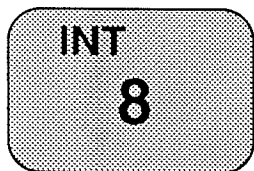

To stop Scan All programme.

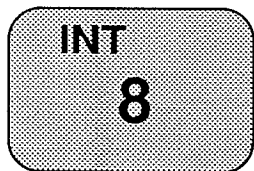

This programme will reinstate all excluded channels in a single operation.



Scan Programme mode allows a limited number of channels to be monitored. A minimum of two and a maximum of ten channels can be pre-selected by the operator. The set will lock on to any

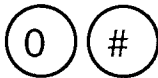
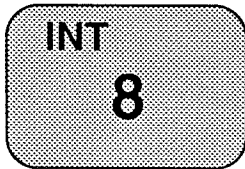

The scan programme must have a minimum of two channels. Channel 5 and 8 are preset, but can be altered. Clear memory and insert new channels.

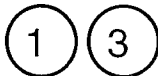
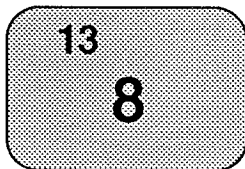

Set in first channel of Scan Programme sequence, for example, Channel 13.

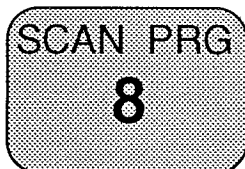

Press immediately, otherwise channel selected will be automatically programmed for transmission.

detected signal for four seconds, when scanning will automatically continue unless a handset is lifted for communication. Squelch must be set above level 1 before this mode can be selected.

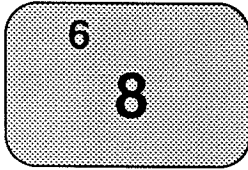

Set in at least one other channel, for example, Channel 6. A maximum of up to eight more channels can also be set in.

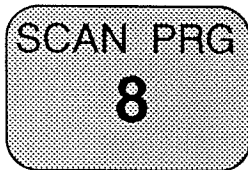

Press immediately.

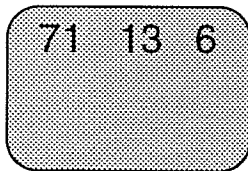

This programme will display all selected channels, in reverse order of scanning.

Channels selected for Scan Programme will be retained in the memory of the set, even if power is switched off.



Start Scan Programme mode.

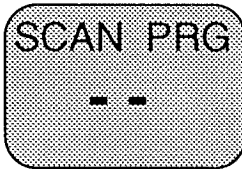

While scanning takes place, channel numbers will not be displayed.

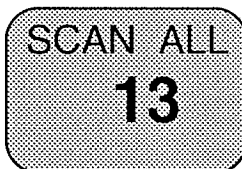

When a transmission is detected, the set will lock on for four seconds and display the number of the channel it is locked on to.

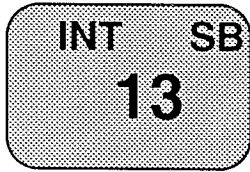

As soon as a handset is lifted, scanning stops, allowing communication with the last channel displayed. The programme automatically goes into stand-by. When the handset is replaced, full scanning will restart.

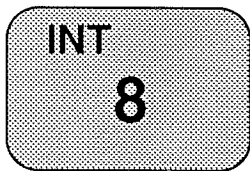

The Scan Programme mode can be stopped at any time.



The Intercom facility allows private conversation between the two handsets, or messages over separate loudspeakers, provided there is no radio traffic on the channel selected.

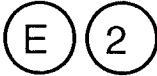
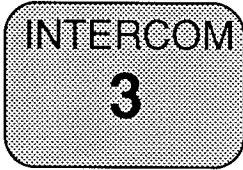

To set up the intercom:
An alarm will sound through the loudspeakers. The second handset should then be picked up, otherwise the message will be heard through the speakers when PTT is pressed.

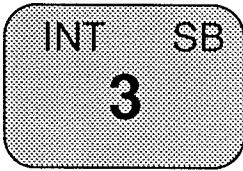

Intercom will automatically go to stand-by when a radio signal is received. Squelch must be set above level 1 before it can be used.

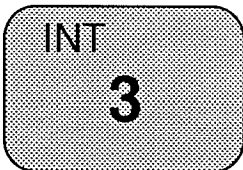

Intercom is cancelled when any programme other than Volume, Squelch, Illumination or Mute is selected, or when the handsets are returned to the cradle.

Muting completely silences the loudspeakers.

Illumination is automatically on when the handset is switched on.

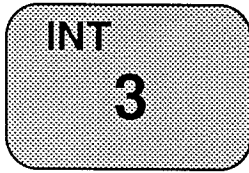

To mute loudspeakers:
This setting will be automatically cancelled when the handset is replaced, or if the same keys are pressed a second time.

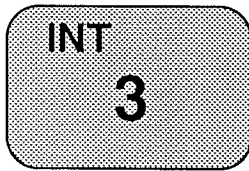

Switch off illumination.

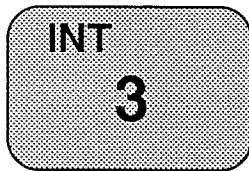

Restore illumination.

INSTALLATION

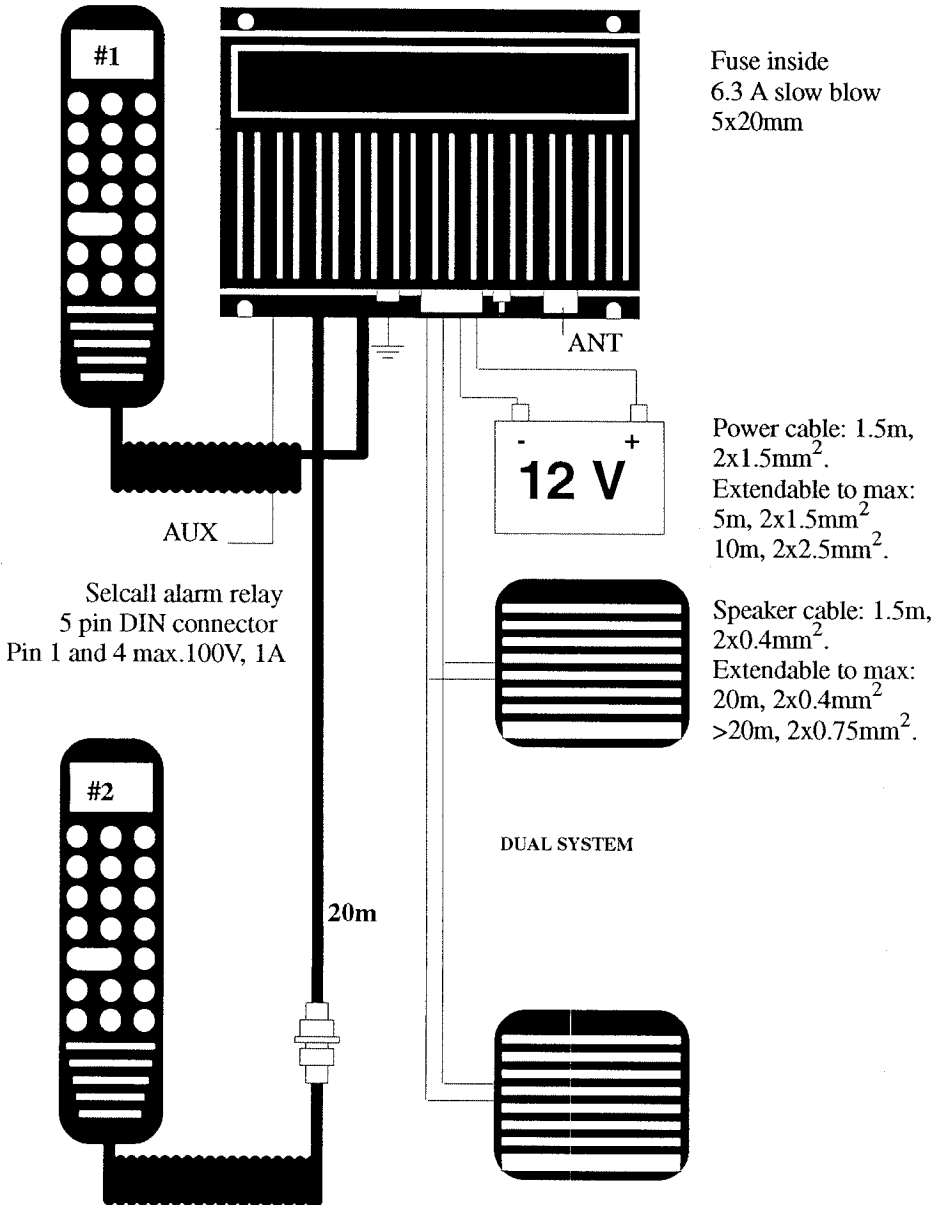

INSTALLATION

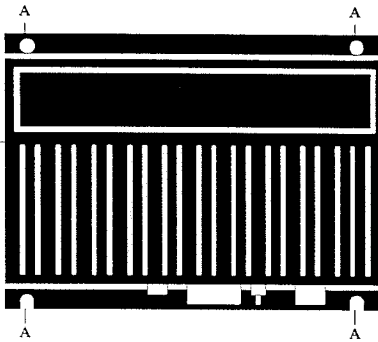

Installation of transceiver unit, handset cradle and watertight socket.

The transceiver unit is not waterproof, so it will have to be installed in a dry place.

1. Fasten the transceiver unit with the 4 screws (included) in the holes marked A.

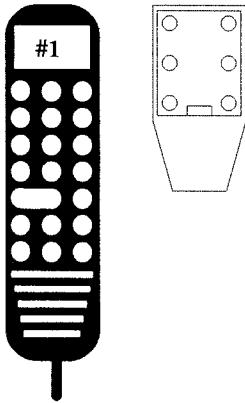

2. Fasten the handset cradle with minimum 4 screws (included).

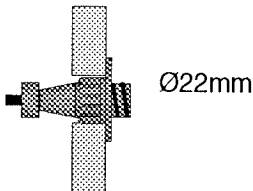

3. Drill a $\text{Ø}22\text{mm}$ hole for the watertight socket.

4. Place the socket in the hole and drill four $\text{Ø}2\text{mm}$ holes for the included 4 screws.

INSTALLATION

Installation of speaker.

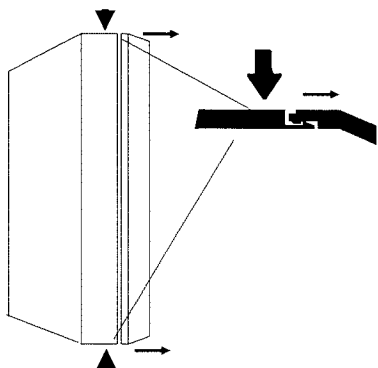

1. Open the speaker by pressing firmly on the top and bottom of the back part, and at the same time pull the front part forward.

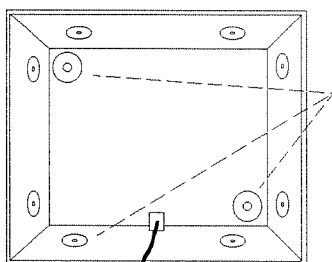

2. Drill out the appropriate holes for installation with a $\text{\O}4\text{mm}$ drill.

3. Lead the speaker cable through the hole of the rear part.

4. Fasten the rear part with the included screws.

5. Connect the speaker cables to the connection terminals.

6. Take the front part of the speaker and press it back together with the rear part.

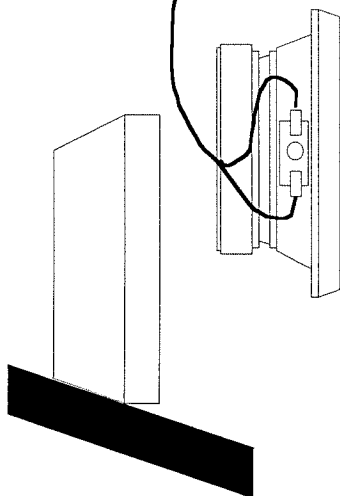

Note! Speakers for the dual version are supplied with fixed cables and switch.

INSTALLATION

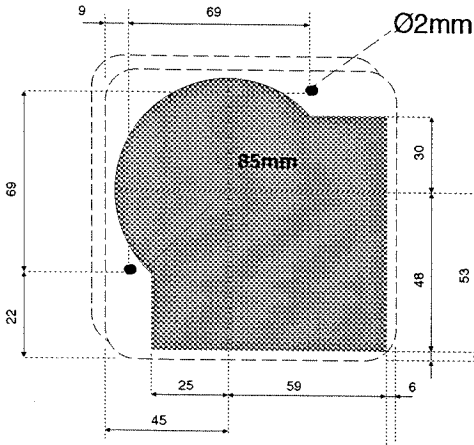

How to flush mount a speaker.

1. Locate the exact position for the speaker.
2. Cut out the hole as indicated (shaded area).

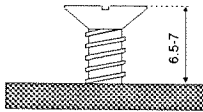

3. Drill two Ø2mm holes.

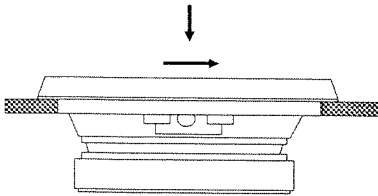

4. Fasten with two 3x14mm self-tapping screws (not included).



5. Insert the speaker into the cutout and slide it into its correct position. The two screws will lock into two keyhole-shaped holes.

Technical Data

General

Power supply:	13.2V dc (12V nominal) isolated earth. Reverse polarity protection.
Operating voltage range:	10.8 to 15.6 V dc
Power drain:	
- receive:	1.5W / 120 mA
- transmit (25W):	60W / 5 A
- transmit (1W):	10W / 0.8 A
- stand-by :	20mW / 0.002 A
Mode:	Simplex / Semi Duplex
Channels:	54 International/US, 130 Private
Facilities:	Scanning, Dual Watch, Priority Key.
Frequency range:	153.9 - 163.1 MHz
Antenna impedance:	50 ohms

Transmitter

Power output:	
- high:	23 - 25W
- low:	1W
AF distortion:	3%
Microphone sensitivity:	4.6mV / 600 ohms

Technical Data

Receiver

Sensitivity:	0.3 μ V / 12 dB SINAD
Squelch sensitivity:	Threshold 10 dB quieting, max. 2 μ V
AF output power:	4W / 4 ohms
Headphone output:	0.775V / 600 ohms

Construction

Main unit:	To IP51. Moisture resistant. Must be located inside, away from possible exposure to water.
Handset:	To IP54. Weather resistant, but not waterproof. Handset may be placed in cockpit and exposed to rain, but not to continuous waves. Handset plug should be protected.
Dimensions:	221 x 152 x 70 mm / 8.7" x 6" x 2.8"
Weight:	2 kg

INTERNATIONAL MARINE VHF CHANNELS

C= Channel D= Duplex □= Only DK, N, S, SF
 P= Public H= Harbour ■= Only N, SF
 S= Ship to Ship X= Receive only ◆= Only UK
 ●= 25 Watt ⊙= 1 Watt

C	D	P	H	S	Remarks	C	D	P	H	S	Remarks	
1	●	●	●			60	●	●	●			
2	●	●	●			61	●	●	●			
3	●	●	●			62	●	●	●			
4	●	●	●			63	●	●	●			
5	●	●	●			64	●	●	●			
6				●		65	●	●	●			
7	●	●	●			66	●	●	●			
8				●		67			●			
9			●	●		68			●			
10			●	●		69			●	●		
11			●			70	DIGITAL SELCALL					
12			●			71			●			
13			●	●		72				●		
14			●			73			●	●		
15			●	●		74			●			
16	SAFETY & CALLING CHANNEL					77				●		
17			●	●		78	●		●			
18	●		●			79	●		●			
19	●		●			80	●		●			
20	●		●			81	●		●			
21	●		●			82	●	●	●			
22	●		●			83	●	●				
23	●	●				84	●	●	●			
24	●	●				85	●	●				
25	●	●				86	●	●				
26	●	●				87	●	●				
27	●	●				88	●	●				
28	●	●										
P1				◆	157.850 MHz	P1 = L1			□		155.500 MHz	
P2				◆	161.425 MHz	P2 = L2			□		155.525 MHz	
P3						P3 = L3			■		155.650 MHz	
P4						P4						

US & CANADIAN MARINE VHF CHANNELS

C= Channel D= Duplex ●= 25 Watt
 P= Public H= Harbour ⊙= 1 Watt
 S= Ship to Ship ★= Receive only ◆= USCG only

C	D	P	H	S	Remarks	C	D	P	H	S	Remarks	
1			●	●		60	●	●	●			
2			●	●		61	●	●	●			
3			●	●		62	●	●	●			
4			●	●		63			●	●		
5			●	●		64	●	●	●			
6				●	Safety	65			●	●		
7			●	●		66			●	●		
8				●		67				⊙		
9			●	●		68			●	●		
10			●	●		69			●	●		
11			●	●		70	DIGITAL SELCALL					
12			●	●		71			●	●		
13			⊙	⊙		72				●		
14			●	●		73			●	●		
15					★	74			●	●		
16	SAFETY & CALLING CHANNEL					77				●		
17			⊙		State controlled	78			●	●		
18			●	●		79			●	●		
19			●	●		80			●	●		
20	●		●			81			◆	◆		
21			◆	◆		82			◆	◆		
22			◆	◆		83			◆			
23			◆			84	●	●	●			
24	●	●			Marine operator	85	●	●				
25	●	●			Marine operator	86	●	●				
26	●	●			Marine operator	87	●	●				
27	●	●			Marine operator	88				●		
28	●	●			Marine operator							
WX1	WEATHER		162.550 MHz		★	WX6	WEATHER		161.775 MHz		★	
WX2	WEATHER		162.400 MHz		★	WX7	WEATHER		162.425 MHz		★	
WX3	WEATHER		162.475 MHz		★	WX8	WEATHER		162.450 MHz		★	
WX4	WEATHER		163.275 MHz		★	WX9	WEATHER		162.500 MHz		★	
WX5	WEATHER		161.650 MHz		★	WX10	WEATHER		162.525 MHz		★	

International Warranty

SHIPMATE warrants that every SHIPMATE product shall be free of failures resulting from materials and workmanship for a period of 12 months from date of purchase.

WARRANTY SERVICE is available through your local authorized service dealer or distributor. Products returned will either be repaired or replaced free of charge. Charges for transportation of a defective product to an authorized service shop are the responsibility of the purchaser.

ON BOARD SERVICE by an authorized technician can be arranged by the local distributor on the request of the purchaser, who will be responsible for all expenses in connection with the service call. Labour charges, replacement of defective modules and parts will be free of charge providing a valid warranty is confirmed by the dealer from whom the product was purchased or by the factory Shipmate International A/S.

VALIDITY: This warranty shall be void unless installation and operation of equipment is carried out in accordance with the unit's manual. This warranty will not apply to any part which has become inoperative due to misuse, accident, neglect or unauthorized repair. This warranty is granted in lieu of and to the exclusion of all other remedies including claims for consequential damages, indirect loss or the like.

AFRICA

JEMBAS-Assistència
Tecnica, Liimitada,
Largo Do Soweto 88,
Luanda, Angola
Tel: +244 222 637 000
Fax: +244 222 637 038

Marine Radio Acoustic
Devices cc
P.O.Box 12076
N1 City 7463
Cape Town, South Africa
Tel: +27 21 559 4003
Fax: +27 21 559 2752

ARGENTINA

RC International
Av. Corrientes 2958 11th 38
1193 Buenos Aires
Tel: +54 11 4865 7621
Tel/Fax: +54 11 4862 5774

AUSTRALIA

Quin Marine Pty.Ltd.
89, St. Vincent Street
Port Adelaide, SA 5015
Tel: +61 88 447 1277
Fax: +61 88 341 0567
www.quinmarine.com.au

AUSTRIA

Simrad GmbH
Koestendorfer Landstrasse 7
A-5163 Mattsee
Tel: +43 6217 203 75

BENELUX

Simrad B.V.
Edisonweg 10,
NL-3200 AM Spijkennisse
Tel: +31 181 600234
Fax: +31 181 626688
www.bennexholland.nl

BRAZIL

Electra Service
P.O.Box 111
11410-971 Guarujá –
Sao Paulo
Tel: +55 3354 3599
Fax: +55 3354 3471

CANADA – see U.S.A.**CHILE**

Simrad S.A.
Casilla 19012,
Correo 19
Vitacura, SANTIAGO
Tel: +56 2 207 3059
Fax: +56 2 207 2695

CHINA

CITE Limited
Rm C-E, 16/F, Yan's Tower,
25-27 Wong Chuk Hang Rd.
ABERDEEN, Hong Kong
Tel: +852 2552 0178
Fax: +852 2873 0679
www.cite.com.hk

CROATIA

Almar d.o.o.
Porec - Kamenarija 12
52452 Funtana
Tel: +38 5 52 445 005
Fax: +38 5 52 445 276

CYPRUS

Regis Marine Electron.Ltd.
163 Leontiou A Street
CY-3360 Limassol
Tel: +357 25 366977
Fax: +357 25 347209

DENMARK

Simrad AS (DK)
Naverland 22
DK-2600 Glostrup
Tel: +45 4344 4900
Fax: +45 4344 4899
www.simrad.dk

ESTONIA

Balti Merekaatrid Marine
Dept.
Pärnu Mnt. 232
11314 Tallinn
Tel: +372 67 10 075
Fax: +372 67 10 099

FINLAND

AT-Marine OY
Mesikukantie 16
SF-01300 Vantaa
Tel: +358 95494 2600
Fax: +358 95494 2700
www.atmarine.fi

(Recreational)

Oy Maritim Ab
Veneentekijäntie 1
SF-00210 Helsinki
Tel: +358 207 65180
Fax: +358 207 652942
www.maritim.fi

FRANCE

Simrad S.A.
Parc d'Activités Ragon
23 Avenue Louis Pasteur
F-44119 Treillieres/Nantes
Tel: +33 2 2801 2301
Fax: +33 2 2801 2143

GERMANY

Simrad GmbH
Lofffuss 43-45
D-24837 Schleswig
Tel: +49 4621 96130
Fax: +49 4621 961329
www.simrad.de

GREAT BRITAIN

Simrad Ltd.
Premier Way
Abbey Park, Romsey
Hampshire SO51 9DH
Tel: +44 (0) 1794 510010
Fax: +44 (0) 1794 510006
www.simradyachting.com

GREECE

Aegean Electronics S.A.
1-3, Akti Miaouli Str.
EL-185 35 Piraeus
Tel: +30 210 413 7269
Fax: +30 210 413 7270

ICELAND

Fridrik A. Jónsson HF
Eyjarslod 7,
IS-121 Reykjavik
Tel: +35 4552 2111
Fax: +35 4552 2115

INDIA

Norinco Private Ltd.
Priya Square
38/265D, Karshaka Road
682 016 Cochin
Tel: +91 484 2323 675
Fax: +91 484 2323 694
www.norinco.co.in

INDONESIA

PT Surya Teknologi
Samudera
Jl. K.H. Abdullah Syafi'ie
No.5
Tebet, Jakarta Selatan
Jakarta 12840
Tel: +62 21 8301975
Fax: +62 21 8302013

ISRAEL

Yamit YSB Ltd.
Tel-Aviv Marina
P.O.Box 6158,
Tel-Aviv 61061
Tel: +972 3 5271779
Fax: +972 3 5271031

ITALY

Simrad Milano Srl.
Via Benadir 14
I-20132 Milano
Tel: +39 02 26149517
Fax: +39 02 8970035
www.simrad.it

JAPAN

Shipmate Japan Co.Ltd.
2-5-4 Fukuura
Kanazawa-ku
Yokohama 236-0004
Tel: +81 45 788 2731
Fax: +81 45 788 2732

Nippon Kaiyo Co. Ltd.
9-2 Sakae-Cho, Kita-Ku,
Tokyo 114-0005
Tel: + 81 3 3913 2337
Fax: +81 3 3913 3479

KOREA

Turn-On Electronics Co.
7th fl., Dong-A Ilbo Bldg.
#53-11, 4KA,
Choongang-Dong
CHONG-KU, PUSAN
South Korea
Tel: +82 51 4623930
Fax: +82 51 4623089

LEBANON

Selcom Marine Sarl
P.O.Box 55541
Dekwaneh Main Street
BEIRUT
Tel: +961 1 491489
Fax: +961 1 495325

MALTA

Medcomms Ltd.
4 Msida Rd.
Gzira - GZR 03
Tel: +356 21 335521
Fax: +356 21 310820

NEW ZEALAND

Advance Trident Ltd.
P.O.Box 4174
Kingsland, Auckland
Tel: +64 9 845 5347
Fax: +64 9 845 5348
www.advancetrident.com

NORWAY

Simrad Marine AS
Joh. Berentsensvei 109
Laksevåg
N-5847 Bergen
Tel: +47 5594 1000
Fax: +47 5594 1005

PERU

Simrad Peru S.A.
Calle Los Topacios 266-
268
Urb. San Antonio
Bellavista - Callao
Tel: +51 1 4537477
Fax: +51 1 4537325

PHILIPPINES

Norwegian Marine
Consultancy, Inc.
Building 1,
Cebu Yacht Club
Pusok Lapu-Lapu City 6015
Tel: +63 32 34 00 292
Fax: +63 32 34 01 194

POLAND

Escort Ltd.
Grudziadzka 3
70-103 Szczecin
Tel: +48 91 431 0400
Fax: +48 91 482 4777
www.escort.com.pl

PORTUGAL

Nautel – Sistemas Electrónicos Lda.
Rua Fernão Mendes Pinto,
n°46
P-1400-146 Lisboa
Tel: +351 21300 7030
Fax: +351 21300 7039
www.nautel.pt

ROMANIA

Intersat Radio Srl.
Str. Vasile Marcovici 7
9100130 Constanta
Tel: +40 241 545 650
Fax: +40 241 555 582

RUSSIA

Moretron Service Ltd.
SIVA Center
Podgornaya Str. Rybny Port
183001 Murmansk
Tel: +7 8152 459781
Fax: +7 8152 459791
www.moretron.ru

Simbia Engineering Co.,Ltd.
4A Verhneozernaja Str.
236018 Kaliningrad
Tel: +7 0112 215492
Fax: +7 0112 365380

Norwegian Partners
Marine AS
5-A Svetlanskaya Str.
690091 Vladivostok
Tel: +7 4232 414627
Fax: +7 4232 300457
www.npm.no

SINGAPORE

Jason Electronics Pte. Ltd.
Blk 194 Pandan Loop 06-05
Pantech Industrial Complex
Singapore 128383
Tel: +65 6 872 0211
Fax: +65 6 872 1800

SPAIN

Simrad Yachting Spain, SL
Avda. Pais Valenciá, N° 28
Nave 14
E-03509 Finestrat (Alicante)
Tel: +34 902 350750
Fax: +34 902 350950

SWEDEN

Simrad AB
Hulda Lindgrensgata 6
S-42668 Västra Frölunda
Tel: +46 31 69 51 00
Fax: +46 31 69 51 20
www.simrad.se

SWITZERLAND

Marine Parts Technics AG
Pfäffikerstr. 6
CH-8604 Volketswil/
Zürich
Tel: +41 1 997 40 90
Fax: +41 1 997 40 94

TAHITI – FRENCH

POLYNESIA
Tahiti Sport S.A.
P.O.Box 62
98713 Papeete
Tel: +689 50 59 59
Fax: +689 42 17 75

TAIWAN ROC

Dragon & Elephant Enter-
prise Co.Ltd.,
12F-4, No. 251
Min Chuan 1st Road
Kaohsiung
Tel: +886 722 72887
Fax: +886 722 72910

THAILAND

Electrical Marine Co. Ltd.
Phuket Boat Lagoon
20/9-10 Moo Thepkasattri
Rd.
Koh Kawe, Muang
Phuket 83200
Tel: +66 76 239 112
Fax: +66 76 239 058

TURKEY

Promar Marine Equip. Ltd.
Igrip Sokak Gul
Apt. No: 7/2
TR-81030 Fenerbahce
Istanbul
Tel: +90 216 3460894
Fax: +90 216 3461493

UNITED ARAB

EMIRATES
Emphor FZCO
P.O.Box 61232
Dubai
Tel: +97 148 830 233
Fax: +97 148 830 133

USA and CANADA

Simrad Inc.
19210 33rd Avenue West,
Suite A,
Lynnwood, WA 98036
Tel: +1 425 778 8821
Fax: +1 425 771 7211

